

JamMan Express XT

Stereo Looper w/JamSync

DiGiTech
by HARMAN



Owner's Manual

Warranty

We at **DigiTech®** are very proud of our products and back-up each one we sell with the following warranty:

1. Please register online at digitech.com within ten days of purchase to validate this warranty. This warranty is valid only in the United States.
2. DigiTech warrants this product, when purchased new from an authorized U.S. DigiTech dealer and used solely within the U.S., to be free from defects in materials and workmanship under normal use and service. This warranty is valid to the original purchaser only and is non-transferable.
3. DigiTech liability under this warranty is limited to repairing or replacing defective materials that show evidence of defect, provided the product is returned to DigiTech WITH RETURN AUTHORIZATION, where all parts and labor will be covered up to a period of one year. A Return Authorization number may be obtained from DigiTech by telephone. The company shall not be liable for any consequential damage as a result of the product's use in any circuit or assembly.
4. Proof-of-purchase is considered to be the responsibility of the consumer. A copy of the original purchase receipt must be provided for any warranty service.
5. DigiTech reserves the right to make changes in design, or make additions to, or improvements upon this product without incurring any obligation to install the same on products previously manufactured.
6. The consumer forfeits the benefits of this warranty if the product's main assembly is opened and tampered with by anyone other than a certified DigiTech technician or, if the product is used with AC voltages outside of the range suggested by the manufacturer.
7. The foregoing is in lieu of all other warranties, expressed or implied, and DigiTech neither assumes nor authorizes any person to assume any obligation or liability in connection with the sale of this product. In no event shall DigiTech or its dealers be liable for special or consequential damages or from any delay in the performance of this warranty due to causes beyond their control.

NOTE: The information contained in this manual is subject to change at any time without notification. Some information contained in this manual may also be inaccurate due to undocumented changes in the product since this version of the manual was completed. The information contained in this version of the owner's manual supersedes all previous versions.

Service Contact Info

If you require technical support, contact DigiTech Technical Support. Be prepared to accurately describe the problem. Know the serial number of your device - this is printed on a sticker attached to the chassis. If you have not already taken the time to register your product, please do so now at digitech.com.

Before you return a product to the factory for service, we recommend you refer to the manual. Make sure you have correctly followed installation steps and operation procedures. For further technical assistance or service, please visit our support page at digitech.com/en-US/support. If you need to return a product to the factory for service, you **MUST** first contact Technical Support to obtain a Return Authorization Number.

No returned products will be accepted at the factory without a Return Authorization Number.

Please refer to the Warranty information, which extends to the first end-user. After expiration of the warranty, a reasonable charge will be made for parts, labor, and packing if you choose to use the factory service facility. In all cases, you are responsible for transportation charges to the factory. DigiTech will pay return shipping if the unit is still under warranty.

Use the original packing material if it is available. Mark the package with the name of the shipper and with these words in red: DELICATE INSTRUMENT, FRAGILE! Insure the package properly. Ship prepaid, not collect. Do not ship parcel post.

Table of Contents

Overview	1
Introduction	1
Features.....	1
 9V Battery Installation	 1
 The User Interface & Connectors	 2
The User Interface	2
Connectors	3
 Connection Diagrams	 4
Standard Looping.....	4
Multi-Track Looping Using JamSync.....	4
Multi-Player/Multi-Track Looping Using JamSync.....	5
 Operation	 6
Recording a Phrase.....	6
Clearing a Phrase	6
Recording Overdubs	7
Undoing/Redoing Overdubs.....	7
Using JamSync.....	8
 Specifications	 11

Overview

Introduction

The JamMan Express XT is a versatile, yet simple to operate stereo looper. With stereo inputs/outputs, three LEDs to indicate looping status, and true bypass operation, the JamMan Express XT allows you to record mono or stereo loops with ease and without compromising your tone when bypassed.

Using the built-in JamSync feature, multiple JamMan Express XT devices can be synchronized to provide multi-track looping capabilities! Cascade two or more JamMan Express XTs for multi-track looping in your own rig or sync with your bandmates' JamSync compatible JamMan devices for multi-track looping with other members in the band!

With a small footprint, simplicity of operation, great sound quality, 10 minutes of stereo loop recording time, and JamSync, the JamMan Express XT is sure to be the perfect looper to compliment your rig. Thanks for choosing DigiTech®.

Features

- Stereo 1/4" Inputs & Outputs
- 10 Minutes of Loop Recording Time
- True Bypass Operation
- JamSync for Multi-Track Looping
- Silent Clear™ Prevents Playback When Clearing Loops
- Intuitive User Interface
- Compatible w/ 9V Battery or PS0913DC Power Supply (Each Sold Separately)

9V Battery Installation

To install a 9V battery:

1. Remove the two screws in the bottom of the chassis using a Phillips screwdriver.
2. Locate the battery connection leads, connect the battery, then place the battery in the battery compartment.
3. Place the bottom plate back on the chassis and replace the two screws. Make sure the battery connection wires are clear of the chassis and screw mounting holes to avoid pinching the wires and causing damage.

The User Interface & Connectors















The User Interface

1. LOOP LEVEL Knob

This knob controls the output level of the loop.

2. Status LEDs

These LEDs indicate the status of the pedal as shown in the below table.

LED	Status
 REC	Loop is being recorded.
 PLAY	Loop is playing.
 DUB	Overdub is being recorded.
 DUB	Overdub is being undone/redone.
 REC  DUB  PLAY	Pedal is in standby (recording/playback stopped).
 REC	Loop is being cleared (footswitch held).
 REC  DUB  PLAY	client armed for record (connected as client via JamSync). client synchronization established via JamSync.
 REC  DUB  PLAY	Low battery.

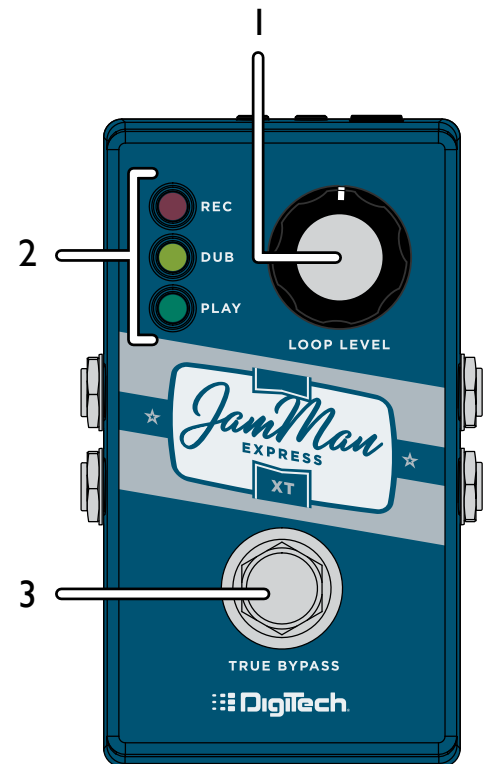

3. Footswitch

The Footswitch is used to perform functions in the JamMan Express XT. It is used to control all looping functions (record, play, overdub, undo/redo, stop, and loop clear).

Connectors

4. Power Jack

Connect an optional PS0913DC power supply to this jack.

5. JAMSYNC OUT

Connect this jack to the JAMSYNC IN jack on another JAMSYNC compatible device for host control over loop playback and stop functions.

6. JAMSYNC IN

Connect this jack to the JAMSYNC OUT jack on another JAMSYNC compatible device to client loop playback and stop functions to a host device.

7. LEFT IN (Mono)

Connect your instrument or additional pedal to this jack. The signal is fed to both outputs when only the LEFT IN (Mono) jack is used.

8. RIGHT IN

Connect a second input to this jack for stereo operation. LEFT and RIGHT inputs are processed separately through the looper engine and then fed to the LEFT and RIGHT outputs to maintain true stereo separation between channels.

9. LEFT OUT (Mono)

Connect this output to the input of a single guitar amplifier or another pedal input.

10. RIGHT OUT

Connect this output to the input of a second guitar amplifier when a second amp is being used.

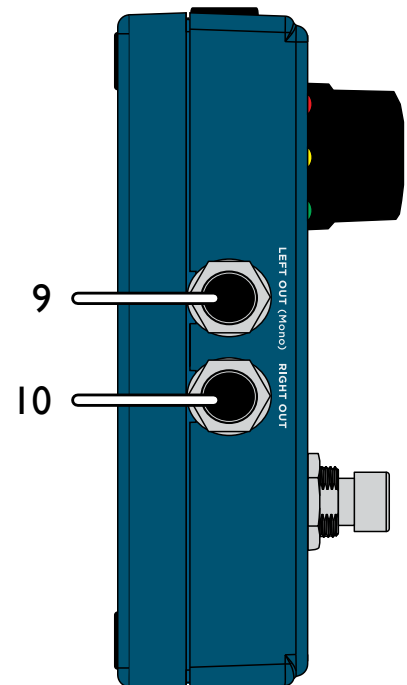
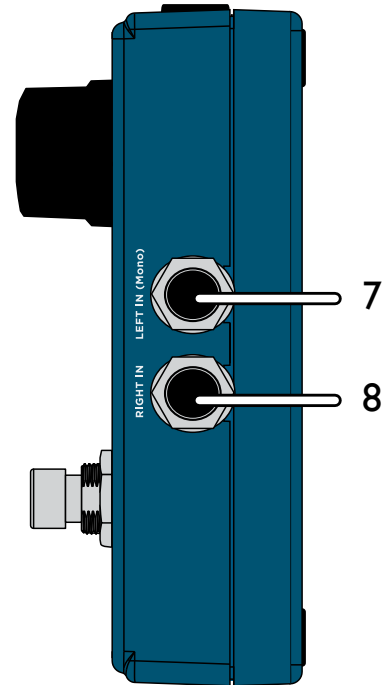
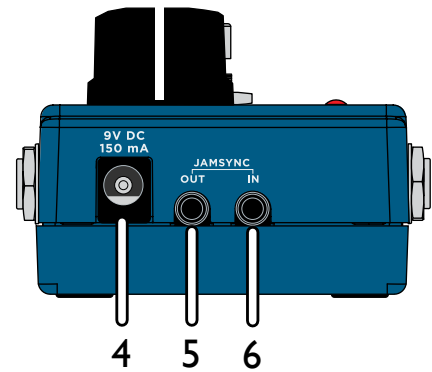

Connection Diagrams

Standard Looping

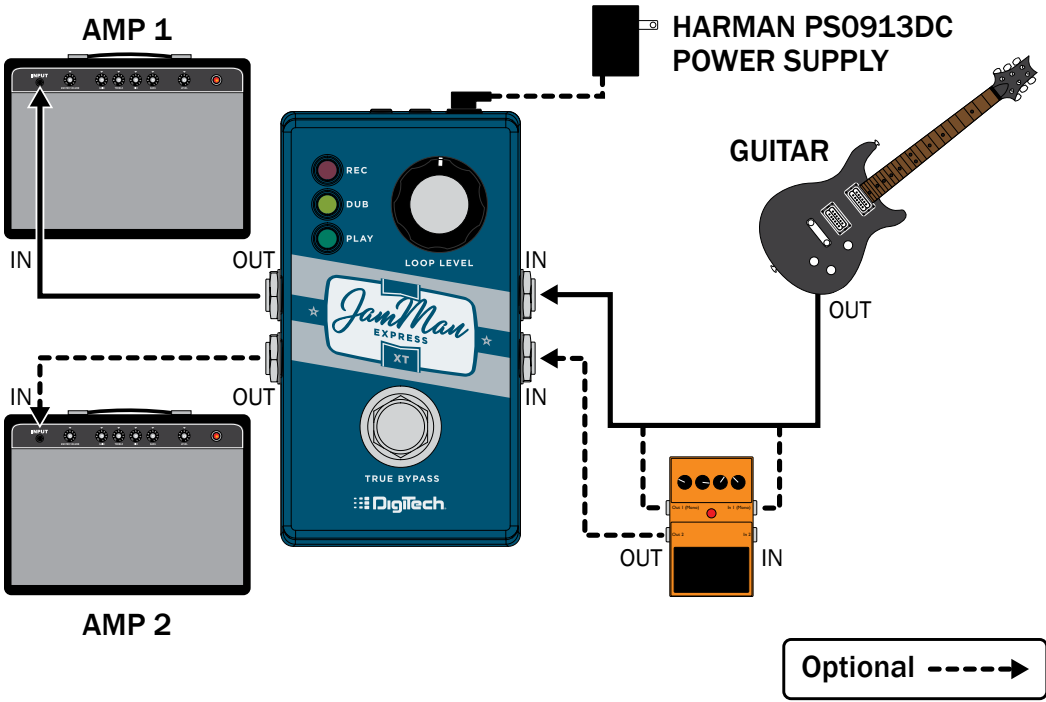

Multi-Track Looping Using JamSync

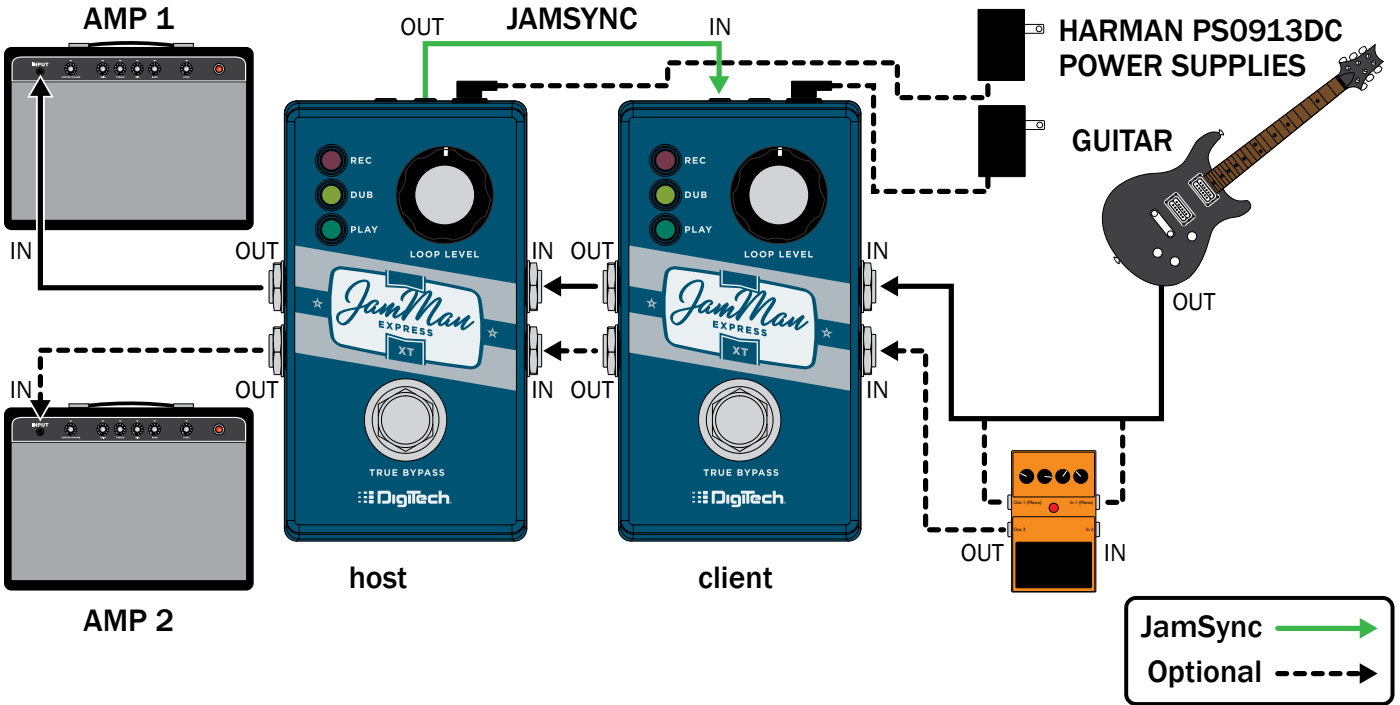

Multi-Player/Multi-Track Looping Using JamSync

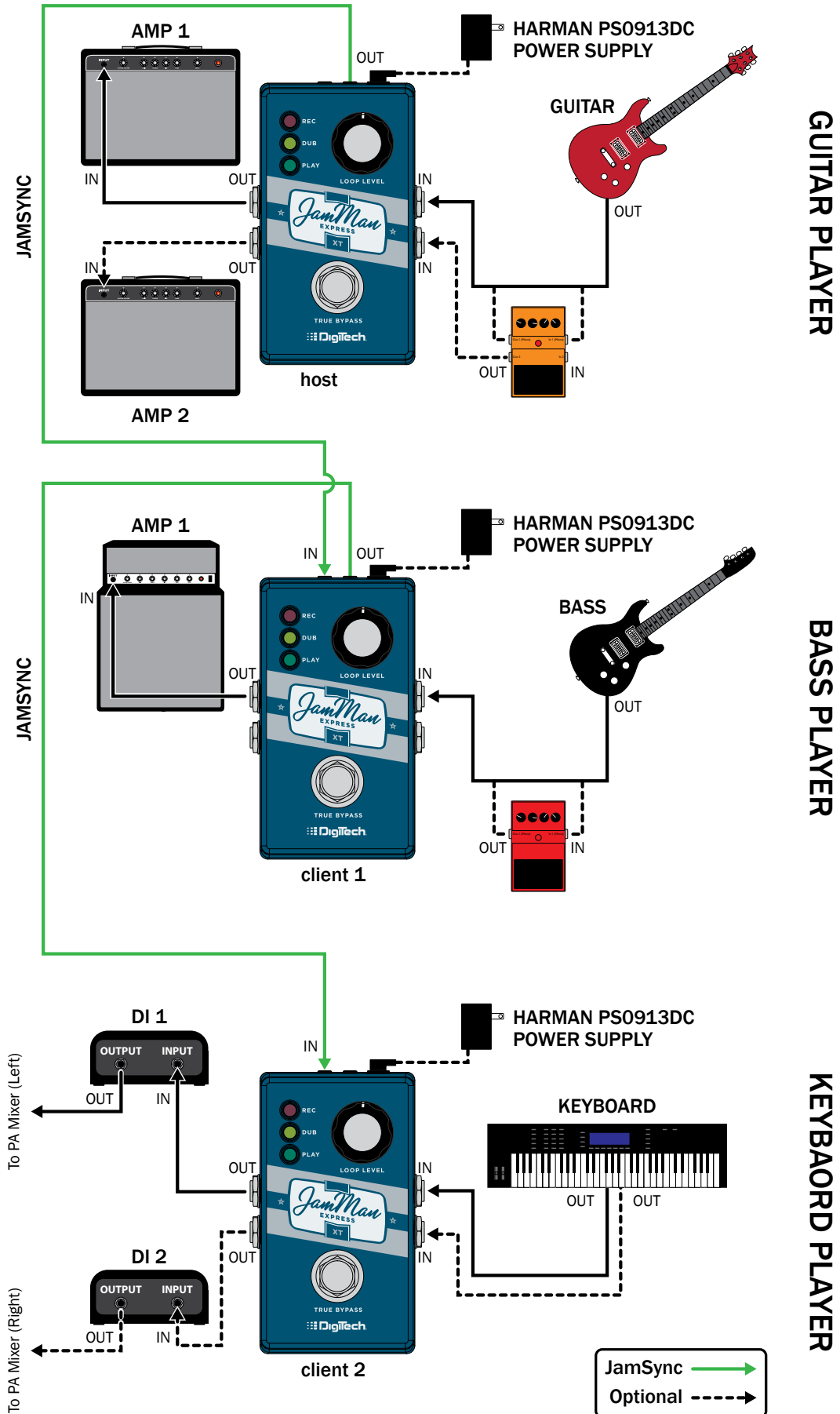

GUITAR PLAYER

BASS PLAYER

KEYBOARD PLAYER

Operation

The JamMan Express XT was designed to be very simple to use right out of the box. This section of the manual describes how to perform the basic looping functions.

Recording a Phrase

The JamMan Express XT records a single phrase and then plays it back as a continuous loop.

To record a phrase:

1. Press the **FOOTSWITCH** and begin playing to start recording. The **REC LED** will light solid red and recording will begin.
2. When finished recording, press the **FOOTSWITCH** once to set the loop end point. The phrase will automatically begin playing back in a repeating loop and the **PLAY LED** will light solid green.
3. Press the **FOOTSWITCH** 2 times quickly to stop loop playback.

NOTE: The maximum phrase recording length is 10 minutes.

Clearing a Phrase

Clear a phrase to re-record it or record a new phrase. The JamMan Express XT has a unique feature, referred to as "*Silent Clear*[™]", which clears a phrase without requiring you to play it first. Note that you cannot undo the process of clearing a phrase, so make sure you want to proceed before performing this function.

To clear a recorded phrase:

1. Stop loop playback if it is not already (all LEDs should be off). If loop playback is active (the **PLAY LED** is on), press the **FOOTSWITCH** 2 times to stop loop playback.
2. Press and hold the **FOOTSWITCH** for ~2 seconds. The **REC LED** will quickly flash red, indicating the phrase has been cleared.

NOTE: When using a client/hostlooper setup, if the host loop is ~3 seconds or less and if pressing and holding the **FOOTSWITCH** from a stopped state does not initiate presses) and hold the footswitch on the 3rd press to clear its loop.

Recording Overdubs

Once a phrase has been recorded, overdubs can be added on top of the phrase.

To record overdubs:

1. Press the **FOOTSWITCH** to start loop playback. The **PLAY LED** will light solid green and the phrase will begin playing.
2. Press the **FOOTSWITCH** again to begin overdub recording. The **DUB LED** will light solid yellow and audio will be recorded on top of the phrase.
3. When done overdub recording, press the **FOOTSWITCH** to end the overdub recording session. The loop will continue playing along with the newly recorded overdub.
4. You can now decide whether you would like to undo the last overdub and re-record it (see "*Undoing/Redoing Overdubs*" in the following section) or proceed and record additional overdubs by repeating steps 2-3.
5. Press the **FOOTSWITCH** 2 times quickly to stop loop playback.

Undoing/Redoing Overdubs

When recording overdubs, you can choose to undo the last overdub recorded if you wish to re-record it. If you change your mind or accidentally undo an overdub, you can then redo the overdub to retrieve it.

To undo/redo an overdub:

1. Record an overdub as described in the previous section, "*Recording Overdubs*".
2. Ensure the loop is playing (the **PLAY LED** should be on). If the loop is not playing, press the **FOOTSWITCH** 1 time to initiate loop playback. Once the loop is playing, press and hold the **FOOTSWITCH** for ~2 seconds. The **DUB LED** will quickly flash yellow, indicating the overdub has been undone.
3. If you wish to restore the overdub, press and hold the **FOOTSWITCH** again for ~2 seconds to redo the overdub. The **DUB LED** will quickly flash yellow, indicating the overdub has been redone.

NOTE: Each time an overdub is added, the last overdub is merged with the original loop and can no longer be undone using the Undo feature. If the combined loop and overdub length exceed 10 minutes (e.g., a 6 minute loop and 6 minute overdub, etc.), the two will automatically be merged and the overdub cannot be undone. Overdubs added to a recorded loop of 5 minutes or less will not be automatically merged.

Using JamSync

Connection & Record Sequence

JamSync allows you to synchronize multiple JamSync compatible devices using optional 1/8" mini stereo (TRS) cables (see below cable diagram). This allows a JamSync host to control the loop playback and stop functions for all connected JamSync clients, providing multi-track looping capabilities. You can cascade multiple JamMan Express XTs for single-player/multi-track looping or collaborate with other musicians, each recording and cueing their own loops for expressive multi-player/multi-track looping.

1/8" Mini Stereo (TRS) Cable Diagram

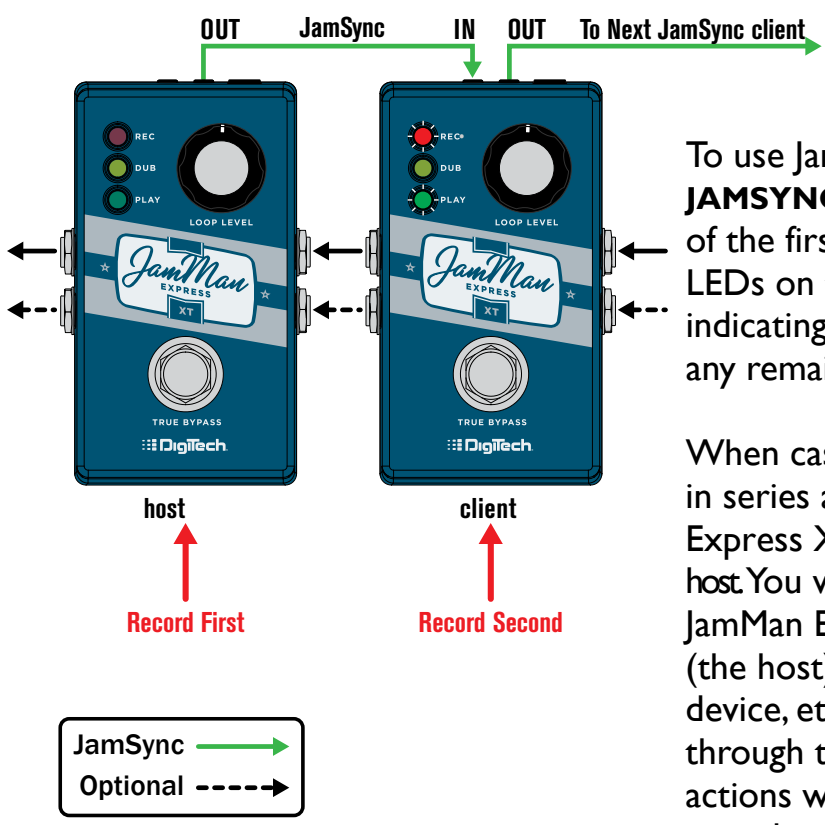
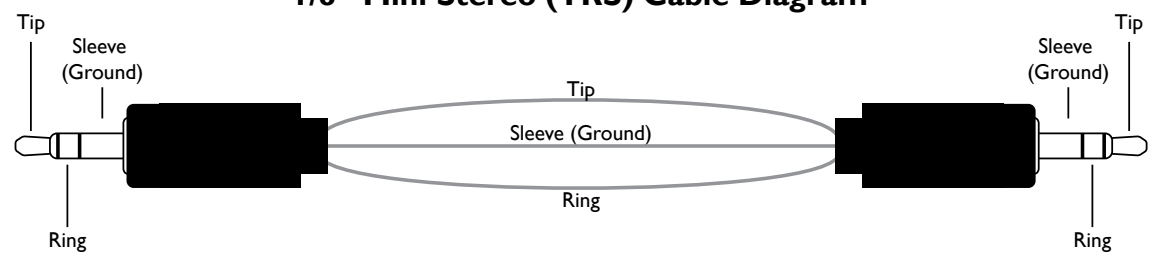

To use JamSync, connect the master device's **JAMSYNC OUT** jack to the **JAMSYNC IN** jack of the first client device. The **REC** and **PLAY** LEDs on the client device will briefly flash, indicating the unit is in clientmode. Daisy chain any remaining clients in the same manner

When cascading multiple JamMan Express XTs in series and using JamSync, the last JamMan Express XT device in the chain should be the host. You will then want to record to the last JamMan Express XT device in the signal chain (the host) first, then the second to last device, etc., working your way backwards through the signal chain. Performing these actions will ensure you record only what you intend to during each pass.

There are two methods for recording loops to a JamSync client JamMan device:

- **Manual client Recording Method**

Using this method, you can record to the host then wait until you're ready to record to the client. This method works well if you do not wish to immediately

record to the client and instead wish to record to the client at a later time in the song. When using this method, you must arm the client to record before the host device reaches its loop start point. It's at this loop start point that the host will send the record command to the client device(s), so the client device must be armed in advance to receive the record command.

- **Sequential Recording Method**

Using this method, you can record to a JamSync client immediately upon setting the loop end point of the host. Use this method when you want to immediately begin recording to the client device after recording to the master device.

To record using the Manual client Recording Method:

1. Press the **FOOTSWITCH** on the host device and begin playing. The **REC LED** will light solid red and recording will begin.
2. When finished recording to the host, press the **FOOTSWITCH** once to set the loop end point. The phrase will automatically begin playing back in a repeating loop and the **PLAY LED** will light solid green.
3. Press the **FOOTSWITCH** on the client device to arm the client for recording. Recording will begin once the host makes another pass of its loop start point (the **REC LED** will light solid red on the client device when recording begins). Once recording has begun, play your part.
4. When finished recording to the client, press the client's **FOOTSWITCH** once to set the loop end point. The phrase will automatically begin playing back along with the host loop and the **PLAY LED** will light solid green.
5. Press the **FOOTSWITCH** on the host device 2 times quickly to stop loop playback on both devices.

To record using the Sequential client Recording Method:

1. Press the **FOOTSWITCH** on the client device. The **REC LED** will flash red, indicating the client is armed for recording.
2. Press the **FOOTSWITCH** on the host device and begin playing. The **REC LED** will light solid red and recording on the host will begin.
3. When finished recording to the host, press the host **FOOTSWITCH** once to set the loop end point. The host device's recorded phrase will begin playing back and the armed client device will immediately begin recording, indicated by the client's **REC LED** lighting solid red.

4. Play your part.
5. When finished recording to the client, press the client's **FOOTSWITCH** once to set the loop end point. The phrase will automatically begin playing back along with the host loop and the **PLAY LED** will light solid green.
6. Press the **FOOTSWITCH** on the host device 2 times quickly to stop loop playback on both devices.

Specifications

DIGITAL

A/D/A Conversion: 24-bit
Max. Individual Loop Time: 10 minutes (stereo)

LEFT(MONO)/RIGHT INPUTS

Connector Type: 1/4" Unbalanced (Tip-Sleeve)
Input Impedance: 550 k Ω Mono/1.1 M Ω Stereo
Unity Gain Input to Output: Loop Level knob set to 12 o'clock position
Max Input Level at Unity: +4 dBu DFS
Left and Right Audio Paths: Each channel maintains analog dry path

LEFT(MONO)/RIGHT OUTPUTS

Connector Type: 1/4" Unbalanced (Tip-Sleeve)/Balanced (Tip-Ring-Sleeve)
Output Impedance: 100 Ω Unbalanced / 200 Ω Balanced
Playback Unity Gain: Loop Level knob set to 12 o'clock position
Maximum Output Level: +4 dBu DFS

PERFORMANCE

Frequency Response: +0/-3 dB 20-20 kHz
Signal to Noise Ratio: > -100 dB

POWER REQUIREMENTS

Consumption: < 2 Watts
Current Draw: < 150 mA
Battery Life: Approximately 2 hours of operation using 9V battery

POWER ADAPTER (SOLD SEPARATELY)

Model: PS0913DC-01 (US, JA, EU)
PS0913DC-02 (AU, UK)
PS0913DC-04 (US, JA, EU, AU, UK)
Input: 100 VAC-240 VAC, 50/60 Hz
Output: 9 VDC 1.3 A
Polarity: 

DIMENSIONS/WEIGHT

Dimensions: 4.5" (L) x 2.75" (W) x 2" (H)
112 mm (L) x 65 mm (W) x 33 mm (H)
Product Weight: 0.6 lb / 0.27 kg
Shipping Weight: 0.75 lb / 0.32 kg

Product specifications are subject to change without notice.
DigiTech, Silent Clear, and JamSync are trademarks of HARMAN.



PHONE: (801) 566-8800

WEB: digitech.com

SUPPORT: digitech.com/en-US/support

JamMan Express XT Owner's Manual
5038282-C

© 2017 HARMAN. All rights reserved.

DigiTech is a registered trademark of HARMAN.

