

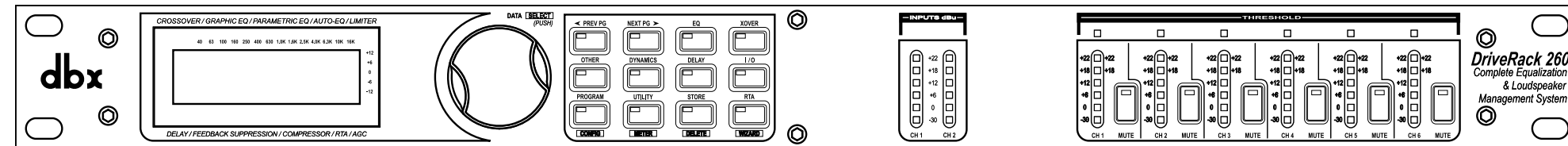

801.566.8800  
dbxpro.com

DriveRack 260 Quick Start Guide  
PN: 5059584-A



# DriveRack 260 Quick Start Guide

## WHAT'S IN THE BOX

- DriveRack 260 Processor
- Power Cable
- Null Modem Cable
- Rack Mount Screw Kit

## PRODUCT REGISTRATION

Register your product at [http://dbxpro.com/en-US/support/warranty\\_registration](http://dbxpro.com/en-US/support/warranty_registration) or scan the code to the right with a QR scanner app on your mobile device.



## DOWNLOAD THE OWNER'S MANUAL

Get the owner's manual at <http://dbxpro.com/en-US/products/driverack-260#documentation> or scan the code to the right with a QR scanner app on your mobile device.



## 1 Getting Started

Before making any audio connections, perform the following:

- Ensure power to your mixer, 260, and amplifier(s) are turned off.
- Turn the attenuators on all power amplifiers or powered speakers all the way down.
- Make the audio connections per your application (see the system diagrams inside this quick start guide for reference).
- Power up the mixer, then the 260, then your amplifiers or powered speakers.

## 2 Run The Setup Wizard

The Setup Wizard will walk you through the configuration process. To run the Setup Wizard, follow these steps:

A. Press and hold the **WIZARD** button for 2 seconds.

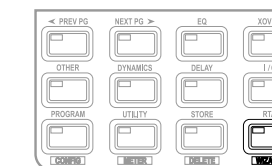

B. Select the "System Setup" Wizard option by pressing the **SELECT** wheel.

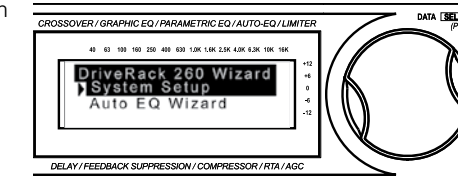

C. Follow the on-screen instructions. Use the **NEXT PG** and **PREV PG** buttons to navigate the Wizard and the **SELECT** wheel to make selections. Select the "Custom" option for amplifier and/or speaker models not listed in the System Setup Wizard.

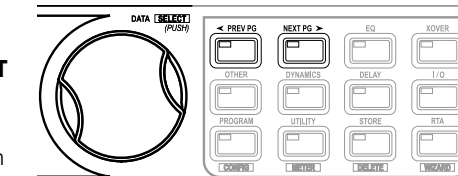

**TIP:** The "GEQ" option must be selected to use the Auto EQ Wizard and the "AFS" option must be selected as one of the inserts to use the AFS Wizard.

**NOTE:** For information on manually configuring the 260 using Configuration mode, see the "Manual Configuration" section inside this Quick Start Guide.

### 3 Auto EQ The System (Optional)

**A.** When the Auto EQ Wizard is reached, connect the optional dbx RTA-M measurement microphone to the RTA MIC INPUT and place it in a mic stand.

**TIP:** If you don't have the RTA-M mic, skip Auto EQ and go to step 4.

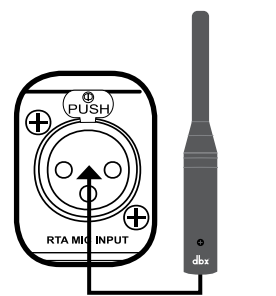

**B.** Place the RTA-M mic as shown in the illustration to the right – the placement of the microphone should form an equilateral triangle with the Front of House loudspeakers.

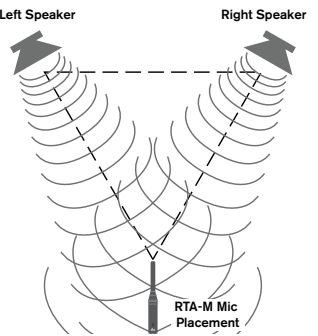

**C.** Press the **SELECT** wheel to select the Auto EQ option from the Wizard Menu list.

**D.** Select the desired Response Curve using the **SELECT** wheel then press the **NEXT PG** button to proceed.

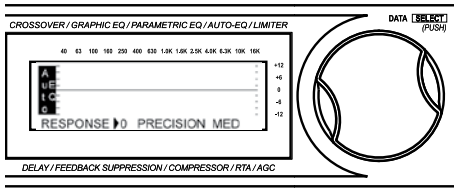

**TIP:** Select the "A" Response option for a live band PA application. Select the "D" Response option for a DJ application.

**E.** Turn the **SELECT** wheel until the pink noise level reaches performance level (the display will read, "SET TO PERFORMANCE LEVEL" once the level is loud enough for Auto EQ to run).

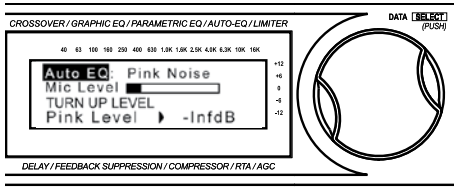

**F.** Press the **NEXT PG** button to start Auto EQ.

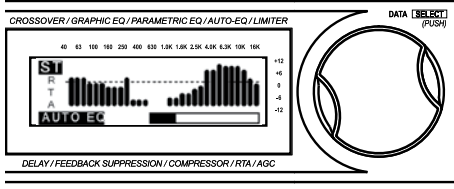

### 4 Ring Out The System For Feedback (Optional)

**A.** To run the AFS Wizard, select the option in the Wizard Menu list by turning then pressing the **SELECT** wheel.

**TIP:** To skip the AFS Wizard, press the **PROGRAM** button.

**B.** Perform a sound check on all microphones that will be used.

**C.** Follow the on-screen AFS Wizard instructions to ring out the system for potential feedback. All mics should be active, but there should be no signal present at the microphones during this procedure.

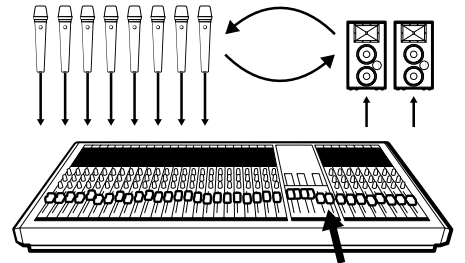

### 5 Store the Preset

**A.** Press the **STORE** button 4 times to store the preset.

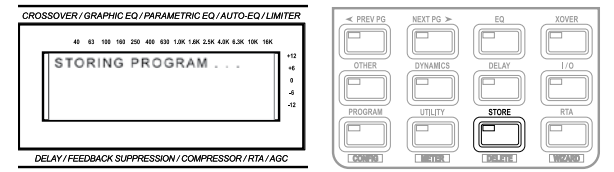

### 6 Control The 260 Using The DriveWare Software App (Optional)

**A.** Connect your computer to the DriveRack 260 using the included RS-232 Null Modem cable as shown in the below diagram.

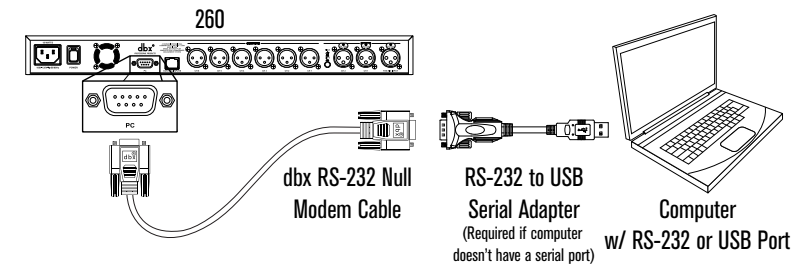

**NOTE:** Not all USB to Serial Adapters will work with the 260. Please visit [dbxpro.com](http://dbxpro.com) for additional information on compatible USB to Serial adaptors.

**B.** Download the DriveWare software application for Windows® from <http://dbxpro.com/en-US/products/driverack-260#downloads>.

**C.** Install the application.

**D.** See the 260 owner's manual for additional information on using the DriveWare software application.

### MONO / STEREO FULL RANGE

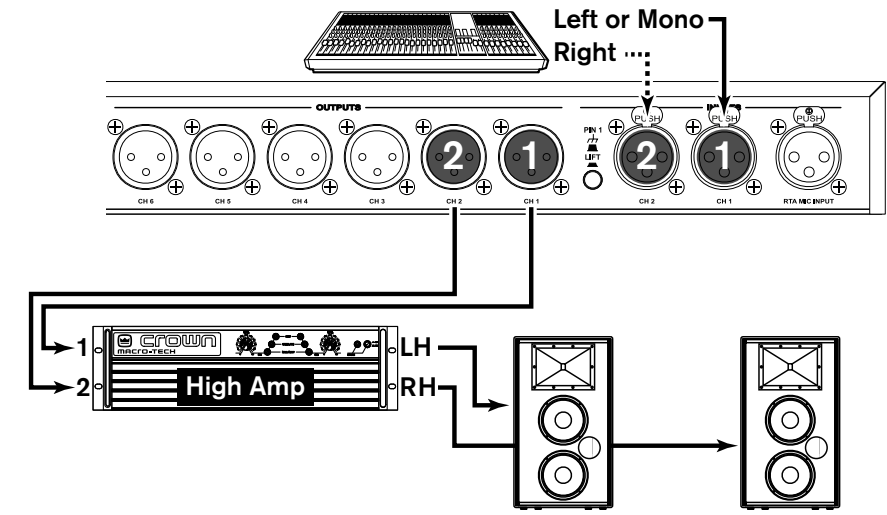

**NOTE:** The LH and RH outputs in this application will pass full-range signal.

### MONO / STEREO 3-WAY

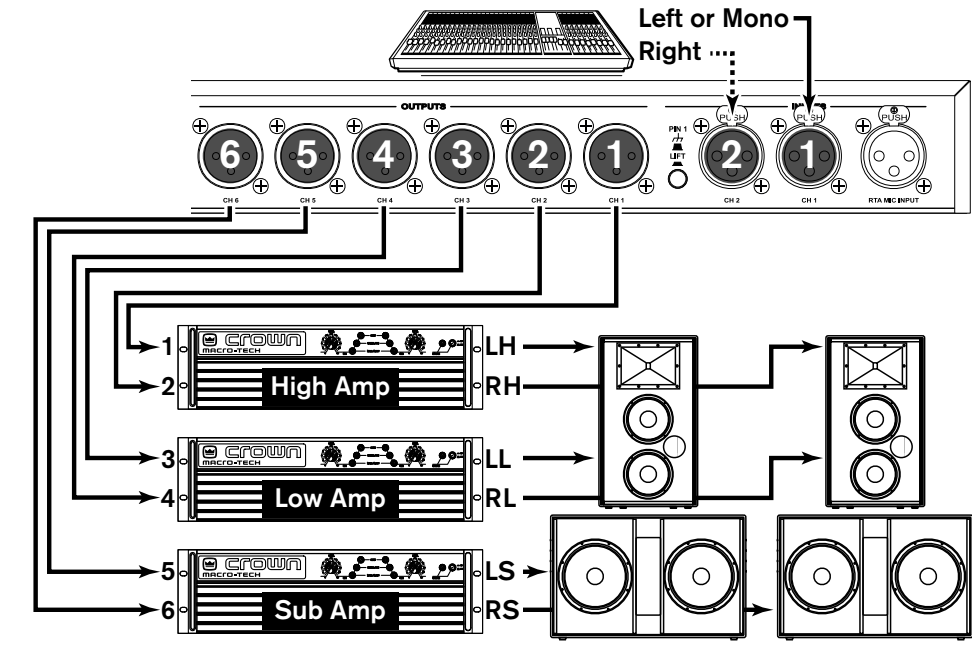

**NOTE:** If any output routing option other than the default is selected at the end of the System Setup Wizard, output connections will differ from those shown above.

### MONO / STEREO 2-WAY

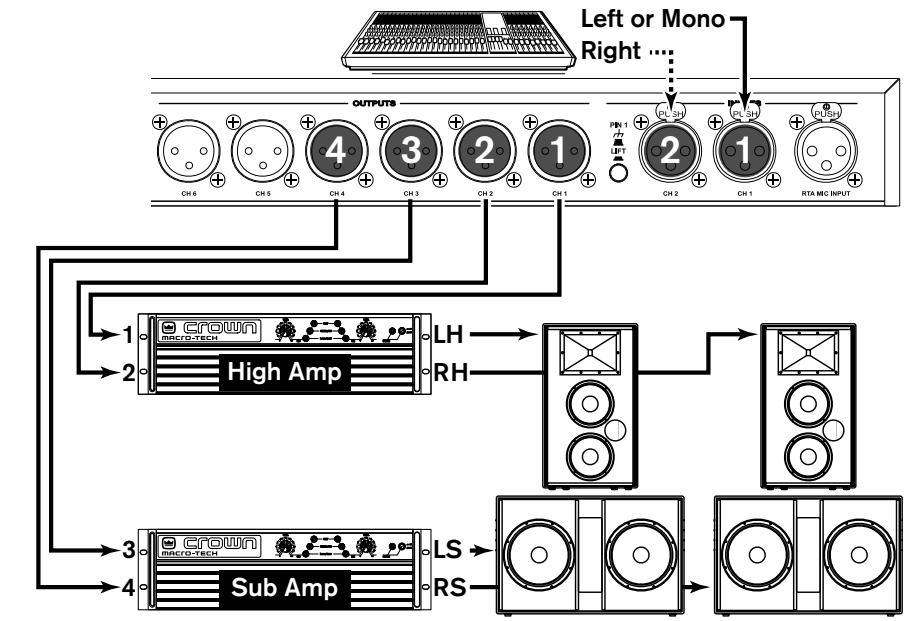

### MANUAL CONFIGURATION

When programming the DriveRack 260 for an application that is more advanced than the Setup Wizard can create, Configuration mode must be used to manually create the program. Configuration mode can be entered by pressing and holding the **PROGRAM/CONFIG** button for two seconds. For more information on using Configuration mode, see the owner's manual.

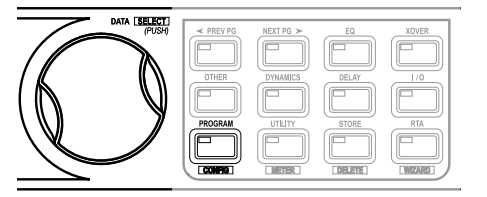

LEGEND		
→	Omit For Mono	
LH	= Left High	LL = Left Low
RH	= Right High	RL = Right Low
LS	= Left Sub	RS = Right Sub