

BDS 270/BDS 570

Blu-ray Disc™ receiver

Owner's Manual



harman/kardon
by HARMAN

IMPORTANT SAFETY INSTRUCTIONS	3
INTRODUCTION	4
VERIFY LINE VOLTAGE BEFORE USING	4
UNPACKING	4
INSTALLATION LOCATION	4
CLEANING	4
MOVING THE RECEIVER	4
SUPPLIED ACCESSORIES	5
RECEIVER FRONT-PANEL CONTROLS	5
RECEIVER REAR-PANEL CONNECTIONS	6
REMOTE CONTROL FUNCTIONS	8
CONNECTIONS	10
PREPARING THE REMOTE CONTROL	14
SETTING UP THE RECEIVER	15
USING THE RECEIVER	19
USING THE DISC PLAYER	21
LISTENING TO YOUR iPod/iPhone DEVICE	23
USING THE RADIO	23
LISTENING TO AUDIO SOURCES	24
PLAYING FILES FROM USB DEVICES AND CD DATA DISCS	24
USING PLAYLISTS	26
TROUBLESHOOTING	27
AUX COMPONENT REMOTE-CONTROL CODE LIST	28
SPECIFICATIONS	33

Important Safety Instructions

1. Read these instructions.
2. Keep these instructions.
3. Heed all warnings.
4. Follow all instructions.
5. Do not use this apparatus near water.
6. Clean only with a dry cloth.
7. Do not block any ventilation openings. Install in accordance with the manufacturer's instructions.
8. Do not install near any heat sources such as radiators, heat registers, stoves or other apparatus (including amplifiers) that produce heat.
9. Do not defeat the safety purpose of the polarized or grounding-type plug. A polarized plug has two blades with one wider than the other. A grounding-type plug has two blades and a third grounding prong. The wide blade or the third prong is provided for your safety. If the provided plug does not fit into your outlet, consult an electrician for replacement of the obsolete outlet.
10. Protect the power cord from being walked on or pinched, particularly at plugs, convenience receptacles and the point where they exit from the apparatus.
11. Only use attachments/accessories specified by the manufacturer.
12. Use only with the cart, stand, tripod, bracket or table specified by the manufacturer or sold with the apparatus. When a cart is used, use caution when moving the cart/apparatus combination to avoid injury from tip-over. 
13. Unplug this apparatus during lightning storms or when unused for long periods of time.
14. Refer all servicing to qualified service personnel. Servicing is required when the apparatus has been damaged in any way, such as power supply cord or plug is damaged, liquid has been spilled or objects have fallen into the apparatus, or the apparatus has been exposed to rain or moisture, does not operate normally or has been dropped.
15. Do not expose this apparatus to dripping or splashing and ensure that no objects filled with liquids, such as vases, are placed on the apparatus.
16. To completely disconnect this apparatus from the AC Mains, disconnect the power supply cord plug from the AC receptacle.
17. The mains plug of the power supply cord shall remain readily operable.
18. Do not expose batteries to excessive heat such as sunshine, fire or the like.

For Products That Transmit and Receive RF Energy:

FCC Regulations (USA Only)

FCC Information For Users

This device complies with Part 15 of the FCC Rules. Operation is subject to the following two conditions: (1) This device may not cause harmful interference; and (2) this device must accept any interference received, including interference that may cause undesired operation.

Radio and Television Interference

This equipment has been tested and found to comply with the limits for a Class B digital device, pursuant to Part 15 of the FCC Rules. These limits are designed to provide reasonable protection against harmful interference in a residential installation. This equipment generates, uses and can radiate radio frequency energy and, if not installed and used in accordance with the instructions, may cause harmful interference to radio communications. However, there is no guarantee that interference will not occur in a particular installation. If this equipment does cause interference to radio or television reception, which can be determined by turning the equipment off and then on, the user is encouraged to try to correct the interference by one or more of the following measures:

- Increase the separation between the equipment and receiver.
- Connect the equipment to a different outlet so that the equipment and receiver are on different branch circuits.
- Consult the dealer or an experienced radio/TV technician for help.

NOTE: Changes or modifications not expressly approved by Harman could void the user's authority to operate the equipment.

IC Statement and Warning (Canada Only)

This Class B digital apparatus complies with Canadian ICES-003. Cet appareil numérique de la classe B est conforme à la norme NMB-003 du Canada.

For Canadian Model

This Class B digital apparatus complies with Canadian ICES-003.

Modèle pour les Canadien

Cet appareil numérique de la classe B est conforme à la norme NMB-003 du Canada.

For Products with Radio Receivers That Can Use an External Antenna:

CATV or Antenna Grounding

If an outside antenna or cable system is connected to this product, be certain that it is grounded so as to provide some protection against voltage surges and static charges. Section 810 of the National Electrical Code, ANSI/NFPA No. 70-1984, provides information with respect to proper grounding of the mast and supporting structure, grounding of the lead-in wire to an antenna discharge unit, size of grounding conductors, location of antenna discharge unit, connection to grounding electrodes and requirements of the grounding electrode.

Note to CATV System Installer:

This reminder is provided to call the CATV (cable TV) system installer's attention to article 820-40 of the NEC, which provides guidelines for proper grounding and, in particular, specifies that the cable ground shall be connected to the grounding system of the building, as close to the point of cable entry as possible.

For CD/DVD/Blu-ray Disc™ Players:

CLASS 1 LASER PRODUCT
KLASSE 1 LASER PRODUKT
LUOKAN 1 LASER LAITE
KLASS 1 LASER APPARAT
CLASSE 1 PRODUIT LASER

CAUTION

RISK OF ELECTRIC SHOCK. DO NOT OPEN.



THE LIGHTNING FLASH WITH AN ARROWHEAD SYMBOL, WITHIN AN EQUILATERAL TRIANGLE, IS INTENDED TO ALERT THE USER TO THE PRESENCE OF UNINSULATED "DANGEROUS VOLTAGE" WITHIN THE PRODUCT'S ENCLOSURE THAT MAY BE OF SUFFICIENT MAGNITUDE TO CONSTITUTE A RISK OF ELECTRIC SHOCK TO PERSONS.



THE EXCLAMATION POINT WITHIN AN EQUILATERAL TRIANGLE IS INTENDED TO ALERT THE USER TO THE PRESENCE OF IMPORTANT OPERATING AND MAINTENANCE (SERVICING) INSTRUCTIONS IN THE LITERATURE ACCOMPANYING THE PRODUCT.

WARNING: TO REDUCE THE RISK OF FIRE OR ELECTRIC SHOCK, DO NOT EXPOSE THIS APPARATUS TO RAIN OR MOISTURE.

Caution:

This product uses a laser system. To prevent direct exposure to the laser beam, do not open the cabinet enclosure or defeat any of the safety mechanisms provided for your protection. DO NOT STARE INTO THE LASER BEAM. To ensure proper use of this product, please read the owner's manual carefully and retain it for future use. Should the unit require maintenance or repair, please contact your local Harman Kardon service center. Refer servicing to qualified personnel only.

For Products That Include Batteries:

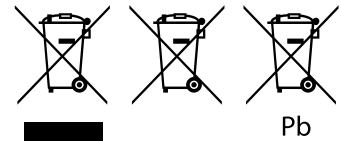

Instructions for Users on Removal and Disposal of Used Batteries.

CAUTION

Risk of explosion if battery is incorrectly replaced. Replace only with the same or equivalent type.

Alkaline batteries are considered nonhazardous. Rechargeable batteries (i.e., nickel cadmium, nickel metal-hydride, lithium and lithium-ion) are considered hazardous household materials and may pose an unnecessary health and safety risk.

In the European Union and other locations, it is illegal to dispose of any battery with household trash. All batteries must be disposed of in an environmentally sound manner. Contact your local waste management officials for information regarding the environmentally sound collection, recycling and disposal of used batteries.

To remove the batteries from your equipment or remote control, reverse the procedure described for inserting batteries in the owner's manual.

For products with a built-in battery that lasts for the lifetime of the product, removal may not be possible for the user. In this case, recycling or recovery centers handle the dismantling of the product and the removal of the battery. If, for any reason, it becomes necessary to replace such a battery, this procedure must be performed by authorized service centers.

BDS 270/BDS 570

Introduction, Verify Line Voltage Before Using, Unpacking, Installation Location, Cleaning, and Moving the Receiver

Introduction

Please register your product on our Web site at www.harmankardon.com.

Note: You'll need the product's serial number. At the same time, you can choose to be notified about our new products and/or special promotions.

Thank You for Choosing Harman Kardon Products!

In the years since Harman Kardon engineers invented the high-fidelity receiver, we have taken to heart this philosophy: Bringing the joy of home entertainment to as many people as possible, adding performance and ease-of-use features that enhance the experience. The BDS series of home entertainment systems offers a complete home entertainment solution with a wealth of listening and viewing options in one sleek receiver.

To get the maximum enjoyment from your new BDS receiver we urge you to read this manual thoroughly and refer back to it as you become more familiar with your new receiver's features and their operation.

If you have any questions about this product, its installation or its operation, please contact your retailer or custom installer, or visit our Web site at www.harmankardon.com.

Verify Line Voltage Before Using

Your BDS receiver has been designed for use with 110 – 240-volt, 50Hz/60Hz AC current and includes a detachable IEC power cable intended for use in the region where the receiver is sold.

Connection to a line voltage other than that for which the unit is intended can create a safety and fire hazard and may damage the units. If you have any questions about the voltage requirements for your specific model or about the line voltage in your area, contact your dealer before plugging the unit into a wall outlet.

Unpacking

The carton and shipping materials used to protect your new receiver during shipment were specially designed to cushion it from shock and vibration. We suggest that you save the carton and packing materials for use in shipping if you move or if the unit ever needs repair.

To minimize the size of the carton in storage, you may wish to flatten it. You can do it by carefully slitting the tape seams on the carton's bottom and collapsing it. You can store cardboard inserts in the same manner. Packing materials that cannot be collapsed should be saved along with the carton in a plastic bag.

If you do not wish to save the packaging materials, please note that the carton and other sections of the shipping-protection materials are recyclable. Please respect the environment and discard those materials at a local recycling center.

Remove the protective plastic film from the front-panel lens. Leaving the film in place will affect the performance of your remote control.

Installation Location

- To ensure proper operation and to avoid the potential for safety hazards, place the unit on a firm and level surface. When placing the unit on a shelf, be certain that the shelf and any mounting hardware can support the weight of the product.
- Provide proper space both above and below the unit for ventilation. If this product will be installed in a cabinet or other enclosed area, make certain that there is sufficient air movement within the area. Under some circumstances, a fan may be required.
- Do not place the unit directly on a carpeted surface.
- Avoid installation in extremely hot or cold locations or in an area that is exposed to direct sunlight or heating equipment.
- Avoid moist or humid locations.
- Do not obstruct the fan vents on the rear panel or the ventilation slots on the top and sides of the unit or place objects directly over or next to them.
- Do not place the receiver directly on top of a product that generates excessive heat.

- Due to the heat generated by the receiver there is the remote possibility that the rubber padding on the bottom of the unit's feet may leave marks on certain wood or wood-veneer materials. Use caution when placing the unit on soft woods or other materials that heat or heavy objects may damage. Some surface finishes may be particularly sensitive to absorbing such marks, due to a variety of factors beyond Harman Kardon control, including the nature of the finish, cleaning materials used, normal heat and vibration caused by the use of the product, or other factors. Your warranty will not cover this type of damage to furniture, so exercise caution in choosing an installation location for the component and in performing normal maintenance practices.
- Your new Harman Kardon Blu-ray Disc™ receiver requires a broadband Internet connection for BD-Live™ interactivity.

Cleaning

When the receiver gets dirty, wipe it with a clean, soft, dry cloth. If necessary, and only after unplugging the AC power cord, wipe it with a soft cloth dampened with mild soapy water, then a fresh cloth with clean water. Wipe it dry immediately with a dry cloth. NEVER use benzene, aerosol cleaners, thinner, alcohol or any other volatile cleaning agent. Do not use abrasive cleaners, as they may damage the finish of metal parts. Avoid spraying insecticide near the unit.

Moving the Receiver

Before moving the receiver, disconnect any interconnection cords to other components, and disconnect the unit from its AC outlet.

Your BDS receiver is designed to be compatible with region management information that is encoded on most Blu-ray Disc recordings and DVD recordings. Your receiver will only play discs that contain region coding for the area where your receiver was shipped and intended for sale:

Area Where Sold	Blu-ray Disc Region Code	DVD Region Code
USA, Canada		
Europe, Middle East		
Korea, S.E. Asia		
Mexico, Latin America		
Australia, New Zeland		
Russia, India		
China		

For example, BDS receivers shipped to and sold in the USA will only play Blu-ray Discs that contain region code A and DVD discs that contain region code 1.

Supplied Accessories

If any of these items are missing, please contact Harman Kardon Customer Service via www.harmankardon.com.

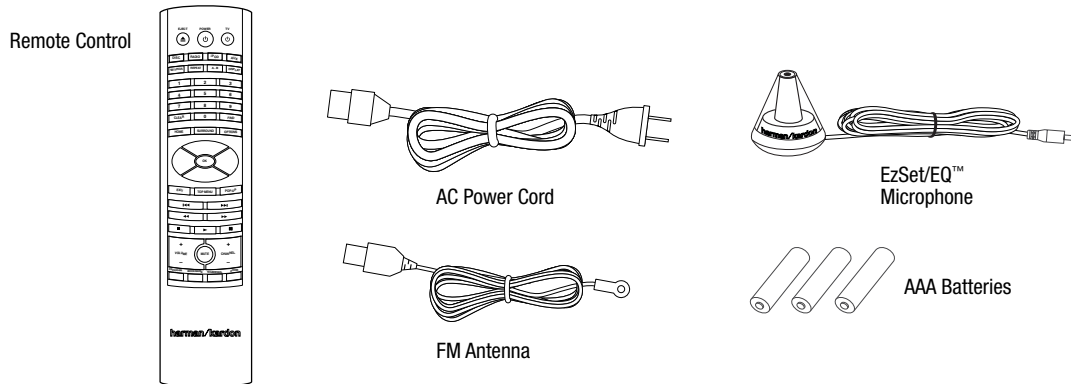

Receiver Front-Panel Controls

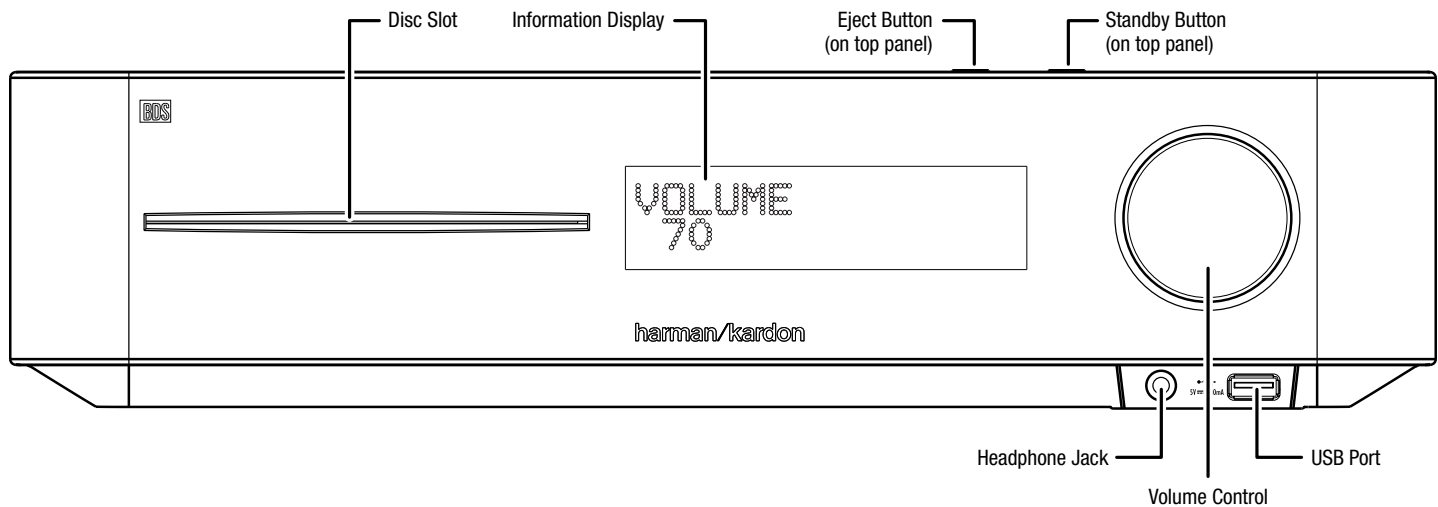

Disc slot: Insert a compatible disc into the slot. The BDS receiver's disc player will accept 5-inch (12cm) and 3-inch (8cm) discs.

Information display: Various messages appear on this display in response to commands and in order to show the audio/video that is playing, the BDS receiver's settings or other aspects of the BDS receiver's status as described throughout this manual.

Eject button (on top of unit): Press this button to eject a disc from the BDS receiver's built-in disc player. Before pressing this button, make sure no objects are blocking the disc-slot opening. NOTE: If you do not remove the ejected disc within 90 seconds, it will automatically re-load back into the disc player for protection.

Standby button (on top of unit): This button toggles the receiver between the On and Standby modes.

Power indicator: This LED surrounds the Standby button. When the BDS receiver is plugged into AC power, the LED turns amber to indicate that the receiver is in Standby mode (ready to be turned on). When you turn the BDS receiver on (by the Standby button or the remote control's Power button), the LED turns white.

Headphone jack: Insert the 1/8-inch (3.5mm) stereo mini connector from a set of headphones into this jack. NOTE: When a plug is inserted into the Headphone jack, the BDS receiver's speaker outputs automatically mute; the HDMI audio output remains active.

Volume control: Rotate the disc clockwise to raise the volume; rotate counterclockwise to lower the volume. The volume level will appear on the Information display.

IMPORTANT: Do not turn the receiver's Volume control up to or past the point where the audio from the speakers becomes distorted. Doing so can damage the speakers.

USB 2.0 port: Gently insert a flash drive or HDD disk drive with a USB Standard-A cable to this port.

IMPORTANT: Do not connect a PC or other USB host/controller to this port, or you may damage both the BDS receiver and the other device.

Orient the device's plug so it fits all the way into the BDS receiver's USB connector. You may insert or remove the device at any time – there is no installation or ejection procedure.

Receiver Rear-Panel Connections

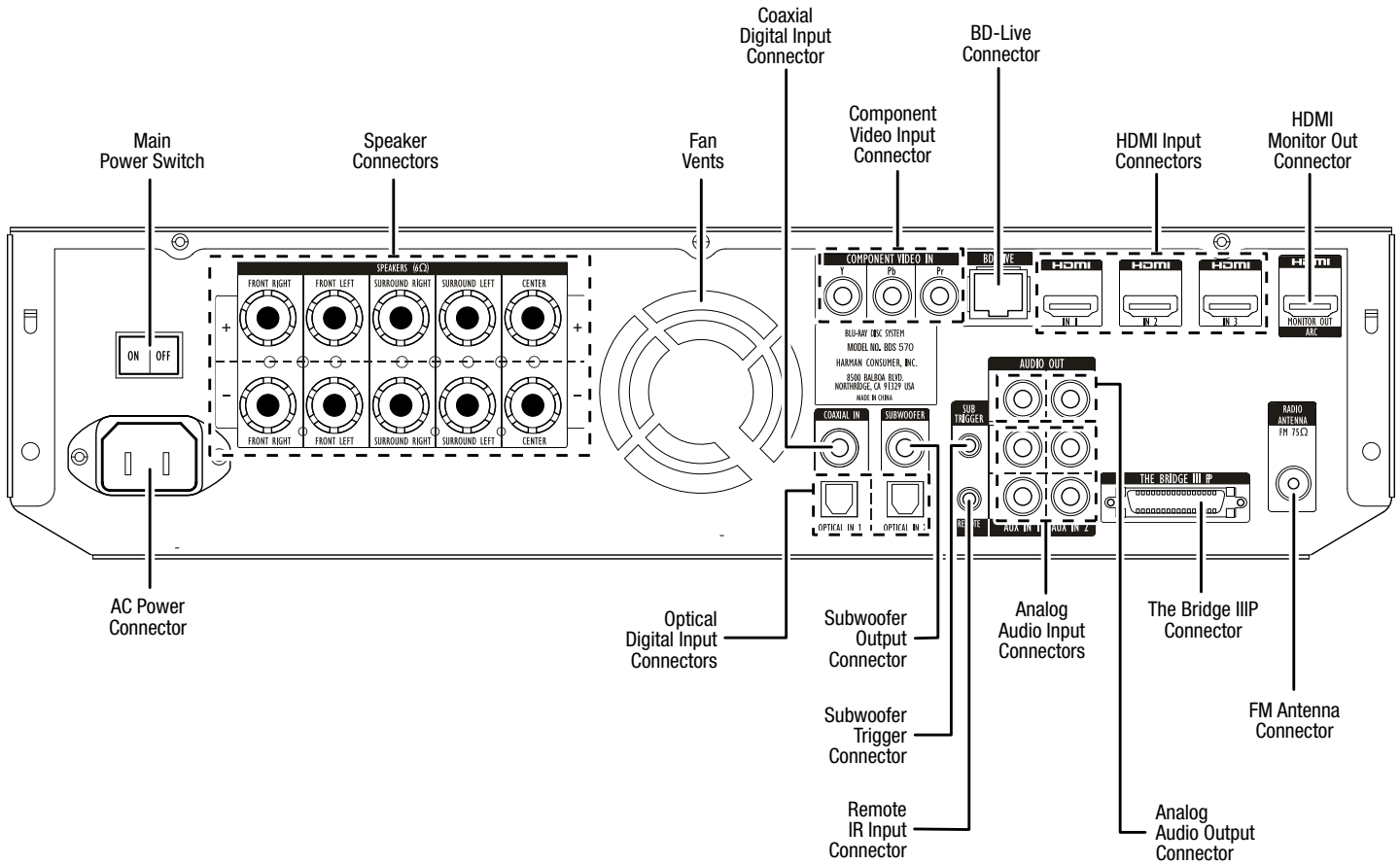

NOTE: See the *Connections* section, on page 10, for detailed information about making connections.

Main Power switch: This mechanical switch turns the BDS receiver's power supply on or off. After you have made and verified all connections (see the *Connections* section, on page 10), set this switch to the "On" position. During normal use you will usually leave this switch set to On; it cannot be turned on or off using the remote control. To conserve energy when you're not going to be using the receiver for an extended period of time, set this switch to "Off."

AC Power connector: After you have made and verified all other connections, plug the supplied AC power cord into this input and into an unswitched AC outlet.

Speaker connectors: Use the speaker wires supplied with the speakers to connect the satellite and center speakers to the proper terminals.

- The BDS 570 receiver (shown) has connections for five speakers: front left, front right, surround left, surround right and center.
- The BDS 270 receiver (not shown) has connections for two speakers: front left and front right.

See *Connections*, on page 10, for more information.

Fan vents: These vents are used by the receiver's fan to cool the unit. Maintain a clearance of at least three inches (75mm) from the nearest surface to avoid overheating the unit. It is normal for the fan to remain off at most normal volume levels. An automatic temperature sensor turns the fan on only when it is needed.

IMPORTANT NOTE: Never block the fan vents. Doing so could allow the BDS receiver to overheat to dangerous levels.

Optical Digital Input connectors: Connect the optical digital output of an audio-only source component here. The signal may be a Dolby® Digital bitstream, a DTS® bitstream or a standard PCM digital-audio bitstream.

NOTE: Use only one type of digital connection for each source component.

Coaxial Digital Input connector: Connect the coaxial digital output of an audio-only source component here. The signal may be a Dolby Digital bitstream, a DTS bitstream or a standard PCM digital-audio bitstream.

NOTE: Use only one type of digital connection for each source component.

Component Video Input connector: If you have a video source device that has a component video connector (and does not have an HDMI connector), use the component video connector. You will also need to make an audio connection from the device to the BDS receiver's Aux In 1 connectors. See *Connections*, on page 11, for more information.

Subwoofer Output connector: Use the supplied mono RCA audio cable (with the purple connectors) to connect this jack to the subwoofer's Line-Level In LFE jack. See *Connecting a Powered Subwoofer*, on page 10, for more details about making connections.

Subwoofer Trigger connector: This connector provides 12V DC whenever the receiver is on. It can be used to turn on and off other devices such as a powered subwoofer.

Remote IR Input connector: When the IR sensor on the front panel is blocked (such as when the receiver is installed inside a cabinet), connect an optional IR receiver to the Remote IR Input connector.

BD-Live connector: To be able to use the BD-Live feature, connect this port to your local area network (LAN) using a Cat. 5/Cat. 5E network cable. See *BD-Live Interactivity*, on page 22, for details.

Analog Audio Input connectors: Use these connectors to connect to an audio-only source component (such as a tape deck). Do not connect a turntable to these connectors without a phono preamp.

HDMI Input connectors (HDMI ver. 1.4a with 3-D): You can connect up to three additional source devices that have HDMI connectors to the BDS receiver. The HDMI connection transmits digital audio and video signals between devices, so you do not have to make any additional audio connections for devices you connect via an HDMI connector. The BDS receiver will pass 3-D video signals from 3-D capable HDMI source devices to the TV via the HDMI Monitor Out connector. See *Connecting Your HDMI Source Devices*, on page 11, for more information.

The Bridge IIP connector: Connect The Bridge IIP iPod/iPhone dock (available separately) to this terminal.

Analog Audio Output connector: Connect this output to an analog recorder's input connector. You can record any signal from the receiver's Analog Audio Input connectors.

HDMI Monitor Out connector (HDMI ver. 1.4a with 3-D): Connect the BDS receiver's HDMI output to your TV's HDMI input. Since the HDMI cable transmits both video and audio to the TV, we recommend that you set the receiver's HDMI audio output to Off in the receiver's Audio menu to take full advantage of your BDS receiver's superior audio performance. The receiver's HDMI Monitor Out connection contains an Audio Return Channel that carries a digital audio signal from your TV or video display back to the receiver. It allows you to listen to HDMI devices that are connected directly to your TV (such as an Internet connection) without making an additional connection from the device to the BDS receiver.

IMPORTANT: Your BDS receiver is in compliance with HDCP (High-Definition Copy Protection). Your TV must also be HDCP-compliant to be used with the BDS receiver's HDMI output. For best results, we do not recommend HDMI connections in excess of ten feet (about 3 meters) without a repeater. If your TV has a DVI input, you may use an optional HDMI-to-DVI cable or adapter for the video connection to the TV. (The DVI connection is video-only.)

FM Antenna connector: Connect the supplied FM antenna to this terminal.

Remote Control Functions

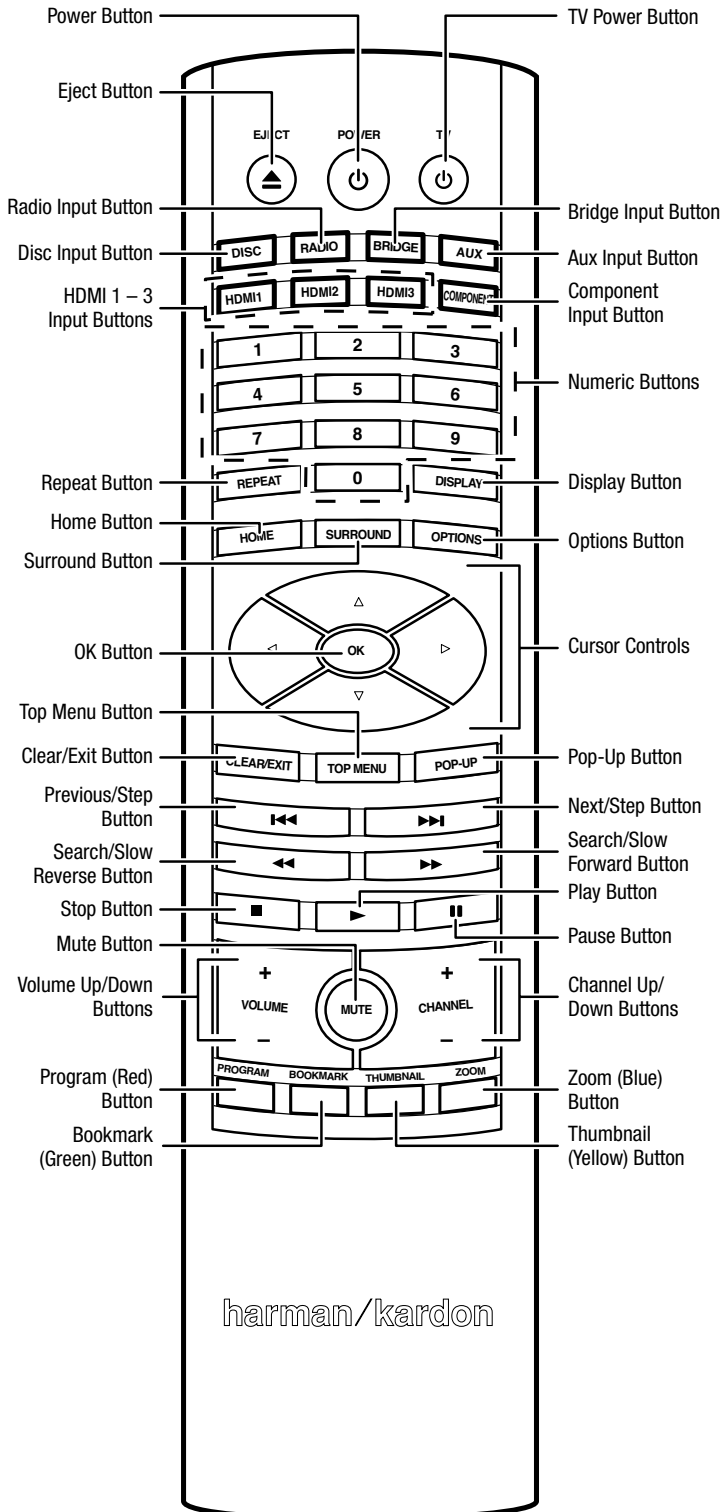

Power button: Pressing this button toggles the BDS receiver between the On and Standby modes.

TV Power button: After you program the remote control, pressing this button turns the TV's power on and off. See *Programming the Remote*, on page 14.

Eject button: Press this button to eject a disc from the BDS receiver's built-in disc player. Before pressing this button, make sure no objects are blocking the disc slot opening.

Radio Input button: Pressing this button selects the BDS receiver's built-in FM radio as the system's active audio source. Pressing this button also puts the remote control into the control mode for the radio. See *Using the Radio*, on page 23, for details. NOTE: Pressing this button when the BDS receiver is in the Standby mode will switch it on.

Bridge Input button: Pressing this button selects an iPod device inserted in a connected The Bridge IIP dock (available separately) as the system's active audio source. Pressing this button also puts the remote control into the control mode for the iPod device. See *Listening to Your iPod/iPhone Device*, on page 23, for details. NOTE: Pressing this button when the BDS receiver is in the Standby mode will switch it on.

Disc Input button: Pressing this button selects the BDS receiver's built-in disc player as your entertainment system's active audio and video source and plays a disc that has been inserted into the player. Pressing this button also puts the remote control into the disc player control mode. See *Using the Disc Player*, on page 21, for details. NOTE: Pressing this button when the BDS receiver is in the Standby mode will switch it on.

Aux Input button: Pressing this button selects the receiver's active rear-panel audio input as the system's active audio source. Repeatedly pressing the button cycles through all of the rear-panel audio inputs. See *Listening to Audio Sources*, on page 24, for details.

Pressing this button also places the remote into the auxiliary-component control mode, enabling the remote to use any pre-programmed and/or learned functions. See *Listening to Audio Sources*, on page 24, for details. NOTE: Pressing this button when the BDS receiver is in the Standby mode will switch it on.

HDMI 1-3 Input buttons: Pressing these buttons selects the device connected to the corresponding HDMI input as the active audio and video source. NOTE: Pressing any of these buttons when the BDS receiver is in the Standby mode will switch it on.

Component Input button: Pressing this button selects the device connected to the Component Video Input connector and the Aux In 1 connector as the active audio/video source. NOTE: Pressing this button when the BDS receiver is in the Standby mode will switch it on.

Numeric buttons: Use these buttons to enter numbers for various items.

Repeat button: When the BDS receiver is playing a Blu-ray Disc recording pressing this button cycles through the following repeat modes: Chapter, Title, Off. When the BDS receiver is playing a DVD, pressing this button cycles through the following repeat modes: Chapter, Title, All, Off. When the BDS receiver is playing a CD or listening to media stored on an iPod or USB device, this button cycles through the following repeat modes: Track, All, Off.

Display button: When you are playing Blu-ray Disc and DVD recordings, pressing this button activates a bar display containing information about the currently-playing disc or program. When you are playing a video or photo slideshow from an inserted USB device, pressing this button displays the Status bar. The button does not function when the BDS receiver is playing material from an iPod device, an auxiliary source or the radio.

Home button: Pressing this button returns the on-screen display to the Home screen from whatever screen is active when the button is pressed.

Options button: Pressing this button displays any available options for the item that is active at the time the button is pressed. When listening to an Aux source, pressing the Options button lets you adjust the audio delay to eliminate "lip sync" errors between the sound and picture when watching video programs with sound playing through one of the receiver's rear-panel audio inputs. See *Listening to Audio Sources*, on page 24, for details.

Surround button: Pressing this button cycles through all of the surround-sound modes that are available for the active program. Each press of the Surround button will change to the next mode in line. A pop-up display will appear, showing the modes as you cycle through them. NOTE: Not all surround modes will be available for all programs. See *Surround-Sound Modes*, on page 21, for more information.

OK button: Press this button to select the highlighted item on the on-screen menu.

Cursor controls: Use these buttons to navigate through items on the on-screen menu.

Top Menu button: Displays the top menu of the Blu-ray Disc recording or DVD that is playing. NOTE: This feature is disc-dependent. Not all DVDs have top menus. If the DVD has no top menu, pressing the Top Menu button may display the disc menu, depending on how the disc's menu system was authored. See *Using the Disc Player*, on page 21, for details.

Clear/Exit button: Pressing this button exits the current on-screen menu and displays the previous screen; it also clears incorrect entries made when entering numbers with the Numeric buttons.

Pop-Up button: Pressing this button while playing a Blu-ray Disc recording or DVD displays its disc menu. NOTE: This feature is disc-dependent. Not all DVDs have pop-up menus. If a DVD has no pop-up menu, pressing the Pop-Up button may display the disc menu, depending on how the disc's menu system was authored.

Previous/Step button: Press this button once to skip to the beginning of a track or, when viewing photos, to the previous photo. Press the button twice to skip to the beginning of the previous track. Press the button repeatedly to go back through the previous chapters or tracks. When video content is playing on Blu-ray Disc recordings and DVDs, press the Pause button first; afterwards, each subsequent press of the Previous/Step button reverses the video one frame.

Next/Step button: Press this button once to skip to the beginning of the next track or, when viewing photos, to the next photo. Press the button repeatedly to advance through the next chapters or tracks. When video content is playing, press the Pause button first; afterwards, each subsequent press of the Next/Step button advances the video one frame.

Search/Slow Reverse button: Press this button to reverse through a disc track. For Blu-ray Disc recordings and DVDs, each press cycles through 2x, 4x, 8x, 16x and 32x reverse speed. Pressing the button while a Blu-ray Disc recording or DVD is paused will reverse through the chapter in slow motion. Each press cycles through 1/2, 1/4, 1/8 and 1/16 normal speed.

Search/Slow Forward button: Press this button to fast-forward through the current disc track. For Blu-ray Disc recordings and DVDs, each press cycles through 2x, 4x, 8x, 16x and 32x normal speed. Pressing the button while a Blu-ray Disc recording or DVD is paused will play through the chapter in slow motion. Each press cycles through 1/2, 1/4, 1/8 and 1/16 normal speed.

Stop button: Press this button to stop playback at the current point. (Pressing the Play button will resume playback from this point.) Press the Stop button twice to stop playback fully. NOTE: Some settings and functions will be available only when the player is fully stopped.

Play button: Press this button to play a disc that has been loaded into the player's disc drawer or a music file that has been highlighted on the on-screen menu. Pressing this button when viewing photos begins a slide show of all photos in the current folder.

Mute button: Press this button to mute the sound from the BDS receiver's speaker outputs. Press the button again to un-mute the sound. NOTE: The Mute button does not mute the HDMI audio output.

Pause button: Press this button to pause a disc or music file that is playing. Pressing the button while a Blu-ray Disc recording or DVD is playing will freeze-frame on the current video frame. Pressing the button while the disc is paused will resume play. Pressing this button while viewing photos freezes the current photo on the screen.

Volume +/- buttons: Press these buttons to increase or decrease the volume of the BDS receiver's speaker outputs. NOTE: The Volume +/- buttons do not change the volume of the HDMI audio output.

IMPORTANT: Do not turn the Volume buttons up to or past the point where the audio from the speakers becomes distorted. Doing so can damage the speakers.

Channel +/- buttons: When Radio is the source selected on the remote control, the Channel +/- buttons select the next higher or lower preset station.

Program (Red) button: Press this button to create a programmed playback list for the currently-playing disc. See *Programmed Play*, on page 22, for more information.

Zoom (Blue) button: Press the Zoom button to zoom in on or recede from a video image or slide. Use the Navigation buttons to zoom in on different sections of the image. NOTE: This function is disc-dependent for Blu-ray Disc recordings and DVDs. Not all discs can be zoomed in on.

Bookmark (Green) button: Press this button to activate the Bookmark function. See *Bookmark Function*, on page 22, for more information.

Thumbnail (Yellow) button: Press this button while playing a photo slide show to display thumbnail images of all photos in the slide show.

Red, Green, Yellow and Blue buttons: When the BDS receiver is playing a Blu-ray Disc recording, these buttons can activate features and menus that may vary from disc to disc. Refer to the menu instructions for each particular disc for more information. NOTE: These Blu-ray Disc functions may override the Bookmark, Thumbnail, Program and Zoom functions.

Connections

CAUTION: Before making any connections to the BDS receiver, ensure that the receiver's AC cord is unplugged from the receiver and the AC outlet. Making speaker connections with the receiver plugged in and turned on could damage the speakers.

Speakers and receivers/amplifiers have corresponding (+) and (-) connection terminals. Most speakers use *red* to denote the (+) terminal and *black* for the (-) terminal.

- The BDS receiver uses *white* to denote the *left* channel (+) terminal and *red* for the *right* channel (+) terminal. Black is used to denote the (-) terminal of both channels.
- The BDS receiver uses the following colors to denote the (+) terminals of the various channels:

Front Left (+): <i>White</i>	Surround Left (+): <i>Blue</i>
Front Right (+): <i>Red</i>	Surround Right (+): <i>Gray</i>
Center (+): <i>Green</i>	

Black is used to denote the (-) terminals of *all* channels on the BDS receiver.

Be sure to connect each speaker identically: (+) on the speaker to (+) on the receiver or amplifier, and (-) on the speaker to (-) on the receiver or amplifier. Miswiring one or more speakers results in thin sound, weak bass and a poor stereo image.

CAUTION: Make sure the (+) and (-) bare wires do not touch each other or the other terminal. Touching wires can cause a short circuit that can damage your receiver or amplifier.

Connecting the Speakers

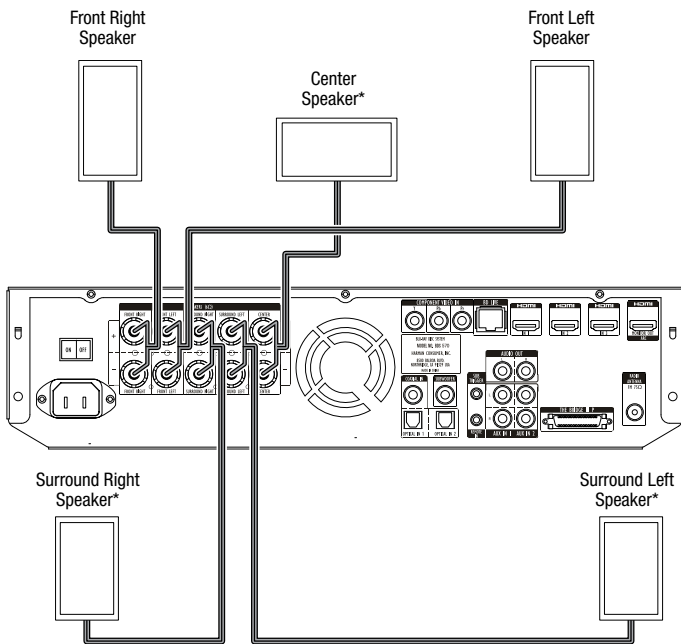

* Used only with BDS 570 receiver

Connecting the Receiver Terminals

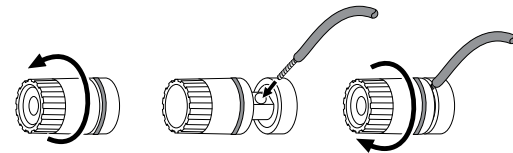

A. Unscrew Cap B. Insert Bare Wire C. Tighten Cap

Connecting a Powered Subwoofer

Use a mono RCA audio cable to connect the BDS receiver's Subwoofer Output connector to your powered subwoofer; consult your subwoofer's user manual for information about making connections to your subwoofer.

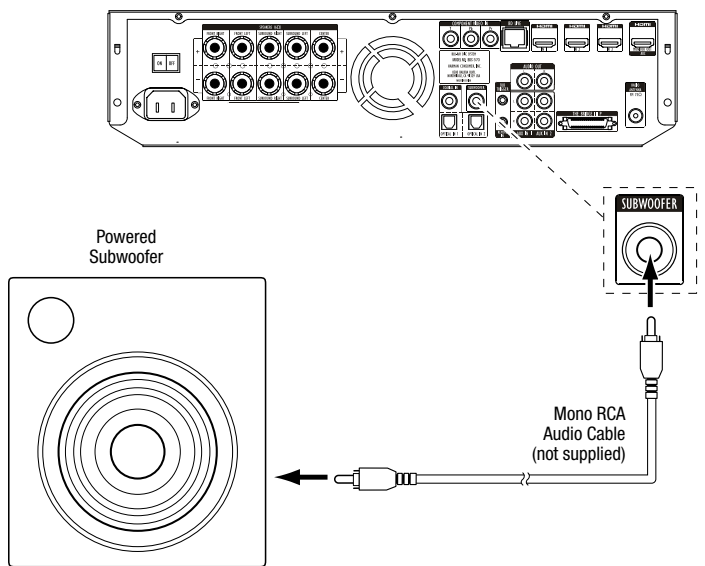

IMPORTANT: Do not plug the subwoofer's AC power cord into an AC outlet at this time.

Connecting the FM Antenna

Connect the supplied antenna to the FM Antenna connector, as shown in the illustration below. Fully extend the antenna wire and move it to different positions until you get the best reception of your favorite stations.

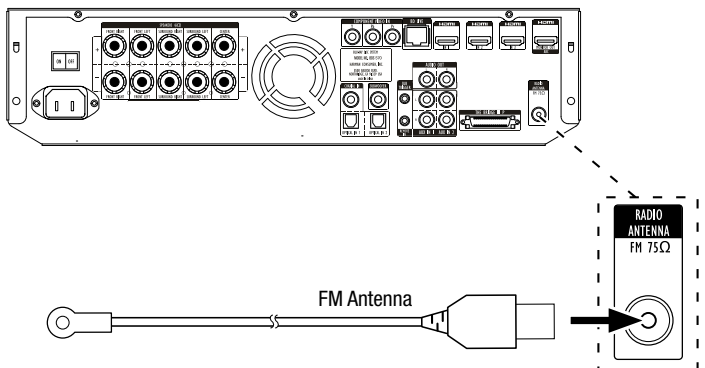

Connecting a TV or Video Display

Use the supplied HDMI cable to connect the BDS receiver's HDMI output to your TV/video display's HDMI input. The BDS receiver is HDMI version 1.4a with 3-D and 30/36-bit Deep Color.

NOTE: If you have devices (such as an Internet modem) already connected directly to your TV, you can feed their sound to the BDS receiver via the HDMI Monitor Out connector's Audio Return Channel, and they will not require additional connections to the receiver.

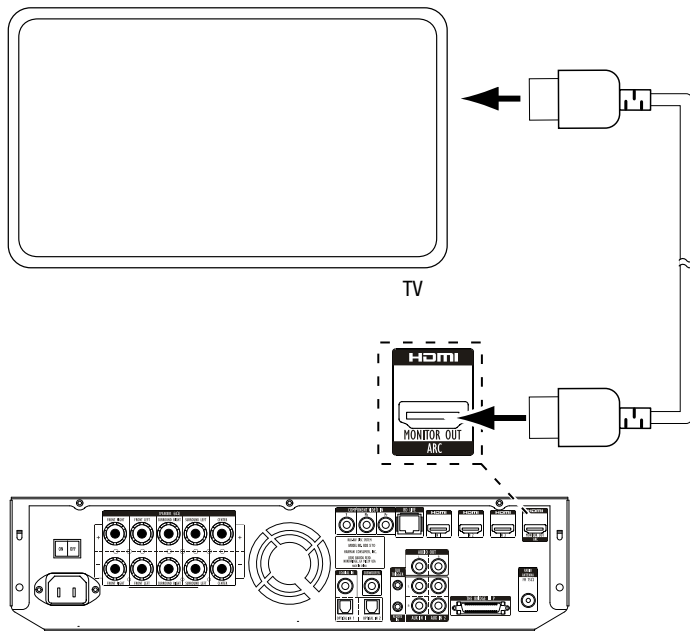

NOTE: The HDMI connection will deliver both video and audio to your TV or video display. We suggest disabling your TV or video display's audio system to take full advantage of your BDS receiver's superior audio reproduction.

Connecting Your HDMI Source Devices

If you have any source devices with HDMI connectors, using them will provide the best possible video and audio performance quality. Since the HDMI cable carries both digital video and digital audio signals, you do not have to make any additional audio connections for devices you connect via an HDMI cable.

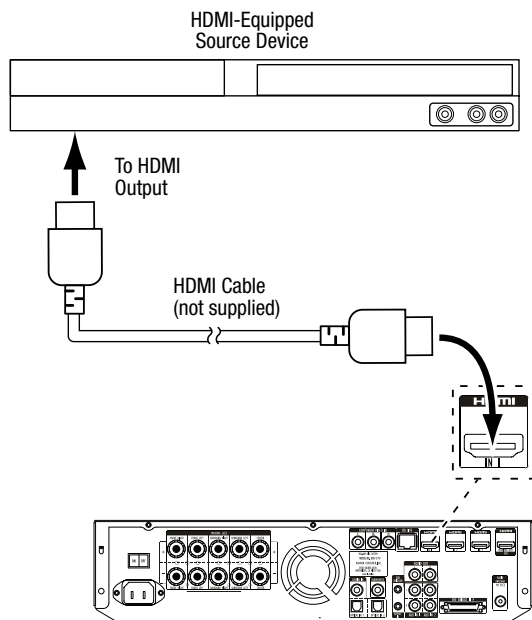

Connecting Your Component Video Source Device

If you have a video source device that has a component video connector (and does not have an HDMI connector), using the component video connector will provide superior video performance. You will also need to make an audio connection from the device to the receiver's Aux In 1 connectors.

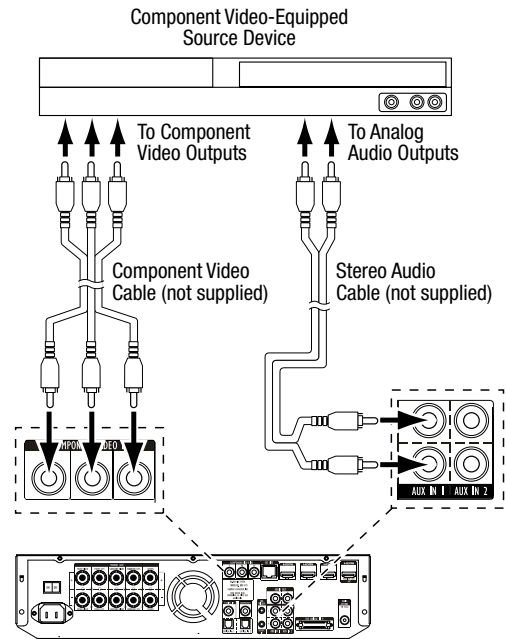

Connecting Your Optical Digital Audio Source Devices

If up to two of your non-HDMI source devices have optical digital outputs, connect them to the receiver's optical digital audio connectors. **NOTE:** Make only one type of digital connection (HDMI, optical or coaxial) from each device.

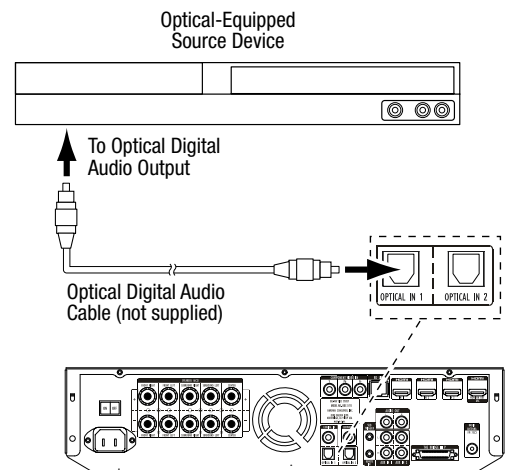

Connecting Your Coaxial Digital Audio Source Device

If one of your non-HDMI source devices has a coaxial digital output, connect it to the receiver's Coaxial Digital Input connector. **NOTE:** Make only one type of digital connection (HDMI, optical or coaxial) from each device.

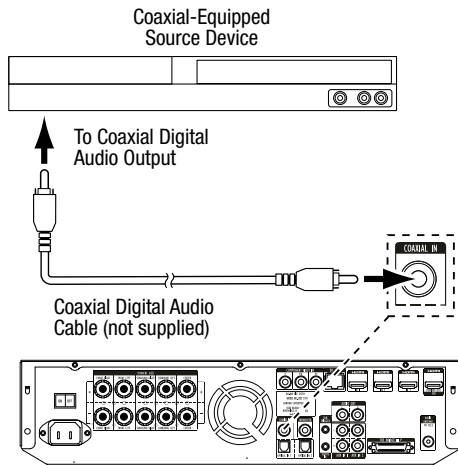

Connecting Your Analog Recorder

Connect an analog audio recorder's inputs to the receiver's Analog Audio Output connectors. You can record any analog audio input signal.

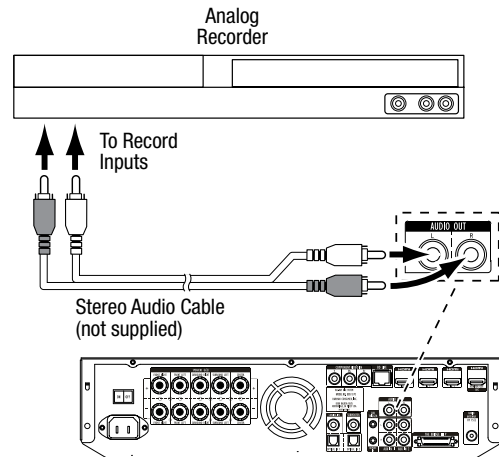

Connecting Your Analog Audio Source Devices

Use the receiver's Aux In connectors for up to two source devices that don't have HDMI or digital audio connectors.

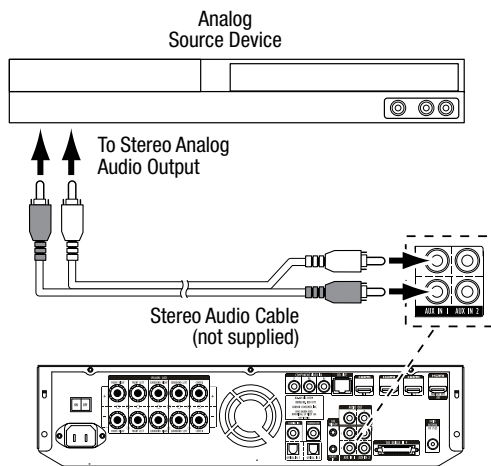

Connect an Optional The Bridge III P

Connect an optional The Bridge III P to the receiver's The Bridge III P connector. Insert the plug until it snaps into place in the connector. **IMPORTANT: Connect The Bridge III P only with the receiver's power turned OFF.**

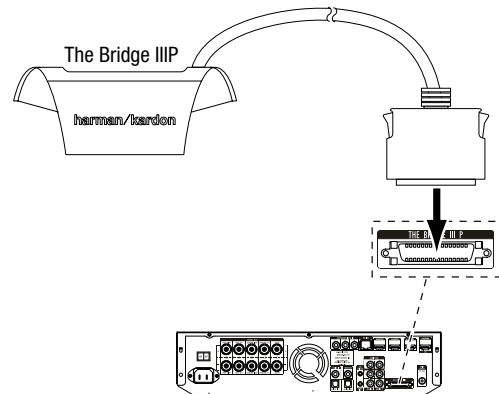

Connecting to a Local Area Network (LAN)

Use a Cat. 5/5E network cable (not supplied) to connect the BDS receiver's BD-Live connector directly to a network router, a network switch, a network modem or an Ethernet network wall jack that has Internet access.

NOTE: The BDS receiver can not access content on other networked devices. The Network connection enables only the receiver's BD-Live features. See *BD-Live Interactivity*, on page 22, for details.

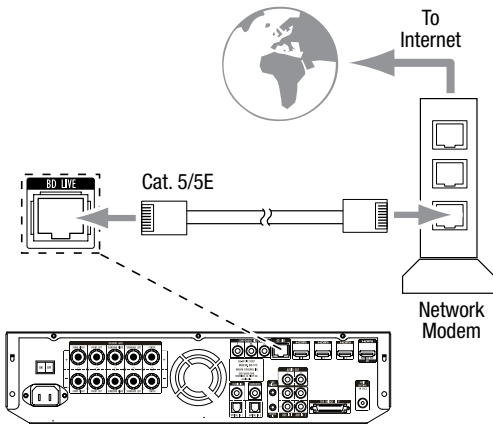

Connect the Subwoofer Trigger Output

If your system has equipment that can be controlled by a DC trigger signal, connect it to the receiver's Subwoofer Trigger connector with a mono 1/8-inch (3.5mm) mini-plug interconnect cable (not supplied). The receiver will supply a 12V DC (100mA) trigger signal at this connection whenever it is powered on.

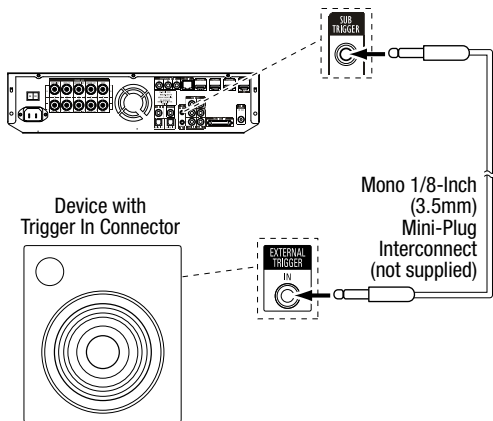

Connect the Remote IR Input

The BDS receiver is equipped with a Remote IR Input connector that lets you remotely control the receiver when you place it inside a cabinet or in a location that is out of the line of sight of the remote control. Connect an external IR receiver, such as the optional Harman Kardon HE 1000, to the receiver's Remote IR Input connector.

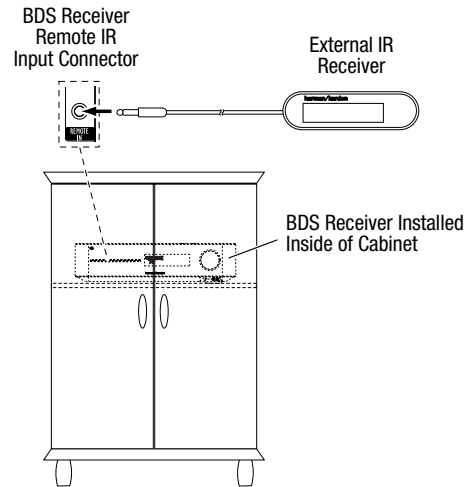

Connecting the AC Power

The BDS receiver comes with a detachable AC power cord. This type of cord makes it easier for you to install and connect all other system wiring to the receiver's rear panel. The subwoofer has a non-detachable power cord.

NOTES:

- The power requirement for the BDS receiver is 110V – 240V AC, 50/60Hz, 130W (BDS 570 receiver) or 90W (BDS 270 receiver). Connecting to a power source other than the ones listed may damage the receiver or cause abnormal operation.
- Before connecting the AC power cord to a wall outlet, confirm that you have correctly made all of the speaker connections, video connections and audio-component connections.

Connect the female end of the receiver's detachable power cord to the receiver's AC Power connector. Plug the other end into a working, *unswitched* AC outlet.

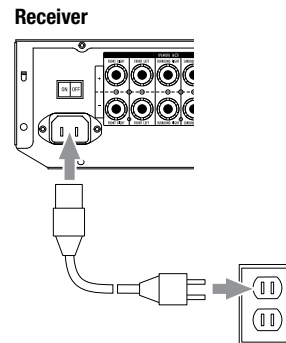

Set the receiver's Main Power switch to the "On" position. The receiver's Power indicator will turn *amber*, indicating that the receiver is in the Standby mode.

Preparing the Remote Control

Installing the Batteries

Your receiver's remote control uses three AAA batteries (supplied). Insert the batteries as shown in the illustration, making sure to observe the correct polarity.

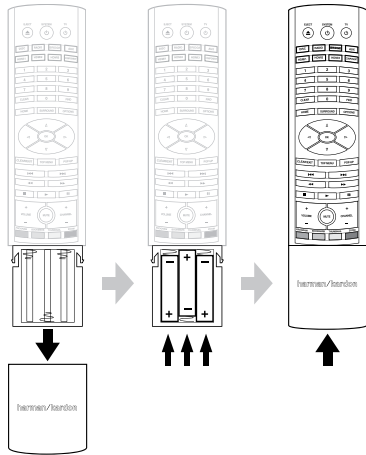

Using the Remote

When using the remote, remember to aim it toward the receiver's front panel. Make sure that no objects, such as furniture, block the remote's view of the receiver. Bright lights, fluorescent lights, and plasma-video displays may interfere with the function of the remote.

- The remote has a range of about 20 feet (6.1 m), depending on the lighting conditions.
- You can use the remote at an angle of up to 30° to either side of the BDS receiver.

If the remote seems to operate intermittently, or if pressing a button on the remote does not cause one of the Input buttons to light up, make sure that the batteries are inserted correctly. If the remote still operates intermittently, replace all three batteries with new ones.

Programming the Remote

In addition to controlling the BDS receiver, you can program the remote to control one auxiliary (Aux) component. The remote is also capable of learning codes directly from other remotes. This ability allows you to combine learned commands with programmed codes, making the remote capable of controlling more than one Aux component. Typical Aux components would be your TV, a satellite receiver or a cable receiver.

The remote will control the Aux component(s) only when the Aux source button has been pressed. Pressing any other source button will put the remote back into the BDS receiver control mode.

To program the remote to control an Aux component:

1. Look up the codes for the component type (e.g. TV or cable TV box) and the brand name of your source in the *Aux Component Remote-Control Code List*, on page 28.
2. Turn your auxiliary component on.
3. Press and hold the Aux button for three seconds as it turns red, goes dark and turns red again. Then release the button.

NOTE: The remote will remain in the programming mode for 20 seconds. You must perform Step 4 within 20 seconds.

4. Aim the remote toward the component you just turned on and enter a code number from Step 1, above. If the component turns off, check that its own remote-control buttons control the component as expected. If they do, press the Aux button again to save the code. The button will flash three times, and the remote will exit the programming mode.
5. If any of the buttons do not work as expected, or if the component does not turn off when you enter the code number, repeat Step 4 with another code number from the list for that manufacturer.

6. If you run out of codes for a component, you can search through all of the codes in the remote's library for that component type.
 - a) Press and hold the Aux button for three seconds. The button will turn red, go dark and turn red again. Then release the button.
 - b) For a conventional US TV, enter "0999"; for a conventional EU TV, enter "1999"; for an HDTV, enter "2999"; for a US cable box, enter "3999"; for an EU cable box, enter "4999"; for a US satellite tuner, enter "5999"; for an EU satellite tuner, enter "6999."
 - c) Aim the remote control toward the component and press the remote's Cursor Up button. Each press of the button sends the "Power" signal for one setup code number. Holding down the Cursor Up button quickly scans through all of the setup code numbers.
 - d) Release the Cursor Up button as soon as the component turns off. If you pass the correct setup code number, you can return to it by pressing the Cursor Down button, one setup code number at a time, until the component turns back on.
 - e) Check that the other remote-control buttons control the component as expected. If they do, press the Aux button again to save the code. The button will flash three times, and the remote will exit the programming mode.
 - f) If the remote does not operate as expected, repeat Steps c – e. Note that some components may not respond to all of the above commands and may support only some of the commands listed.

To teach individual button codes to the remote:

You can teach codes from other component remotes onto the BDS receiver remote buttons shown shaded in the following illustration:

■ = Learning Capable

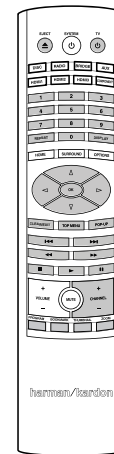

1. Place the BDS receiver remote and the remote from which you want it to learn codes head-to-head about 1 inch (2.5cm) apart, with their IR transmitter windows facing each other.
2. Press and hold the Options button on the BDS receiver remote for more than three seconds. The remote's Aux button will light up.
3. Press the button on the BDS receiver remote to which you want to teach the command. The Learn mode will remain active for 20 seconds after the button is pushed.
4. Press the button on the other remote that you want to "teach" to the BDS receiver remote. When the IR code has been received and stored, the Aux button's LED will flash three times, and the BDS receiver remote will remain in the learning mode, ready to learn another code. If no IR code is received within 20 seconds, the Aux LED will flash rapidly several times, and the remote will exit the learning mode. To resume programming, return to Step 2.
5. Repeat Step 3 and Step 4 for each command you want to teach the BDS receiver remote. **NOTE:** If the Aux button's LED goes out at any time, you will need to begin again from Step 2.

Programming Remote Control “Punch-Through” Commands

After programming the remote to control an auxiliary (Aux) component, you can also program it so it will control the Aux component’s channel up/down and transport functions (Play, Pause, etc.) even when the remote is not in the Aux-control mode. For example, if the remote is programmed to operate your TV in the Aux control mode, you can also have the TV’s channel +/- functions “punch through” and operate even when the remote is in the Disc, Radio or iPod control modes.

1. Press and hold the Input button for the main device the remote will be operating. The button will light up, go dark and then light up again. Release the button.
2. Select the type of punch-through programming.
 - a) For “punch-through” channel control, press the Channel Up button.
 - b) For “punch-through” transport control, press the Play button.
3. Press the Aux button. The original Input button will flash to confirm.

You can repeat Step 1 – Step 3 for any of the remote’s Input buttons (Aux, Radio, etc.).
NOTE: “Punch-through” channel and transport commands will override the existing commands for those buttons in the source modes you program.

To undo “punch-through” programming, follow the same steps as above, but press the same Input button in Step 1 and Step 3.

Erasing All Learned Button Codes

1. Press and hold the Options button for more than three seconds. The remote’s Aux Input button will light up.
2. Press the Aux Input button. The button will flash.
3. Hold down the “9” number button for at least three seconds, three times in a row. The Aux Input button will flash three times then will go out. All learned button codes have now been erased.

Resetting the Remote to Factory Default Condition

1. Press the Aux Input button and the “0” number button simultaneously. The Aux button will light up.
2. Hold down the “3” number button for at least three seconds, three times in a row. All of the input buttons will flash three times.
3. After the input buttons stop flashing, all remote programming has been erased and the remote is reset to its factory default programming.

Using the Remote After it is Programmed

Pressing the remote’s Aux Input button will put the remote into the auxiliary-control mode, and it will control the auxiliary component(s) via the codes you have programmed into it.

To switch the remote back to the BDS receiver-control mode from the auxiliary-control mode, press any of the other Input buttons or the Home button.

Setting Up the Receiver

NOTE: The menu screens shown in this manual are for illustrative purposes and may differ somewhat from the actual displays.

To set up your BDS receiver, you will use the remote to navigate through all of the on-screen menus and to make selections from them.

- Use the Cursor Up/Down buttons to navigate through the menu list. When an item is highlighted, a blue border will appear around it.
- To select a highlighted item, press the OK button. The screen will change depending on your selection.
- To return to the previous screen, press the Previous button.

Setup Wizard

When you turn your BDS receiver on for the first time, the on-screen menu will display the Setup Wizard.

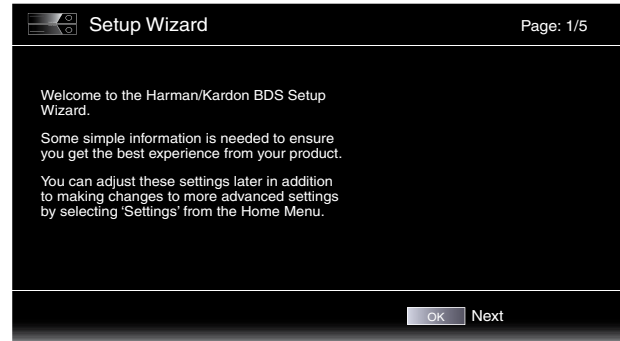

Before you can use your BDS receiver, you need to set the language and make a few basic settings so that its video output will work properly with your TV. Press the OK button and the Wizard’s language screen will appear.



After setting the language you want the on-screen menus to appear in, press the OK button and the Wizard’s TV-resolution screen will appear.

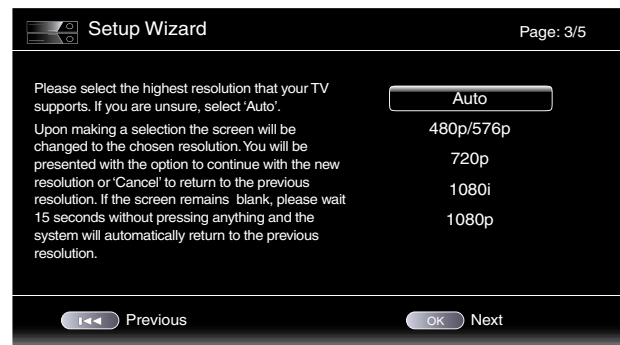

After selecting your TV's highest resolution, press the OK button, and the Wizard's aspect-ratio screen will appear. Note: If you are unsure of your display's highest resolution, select "Auto" and the BDS receiver will select the optimal resolution for you.



After selecting the aspect ratio that best fits your TV, press the OK button to save your setting, then press it again to exit the Setup Wizard.

Settings Menus

Selecting "Settings" on the Home Menu screen displays the receiver's settings menus, which allow you to configure the receiver's various functions. Use the remote's Cursor Left/Right buttons to change from one menu to another, use the Cursor Up/Down buttons to navigate through the lists that appear on the various screens, and use the OK button to select highlighted items. Press the Exit button at any time to return to the previous screen.

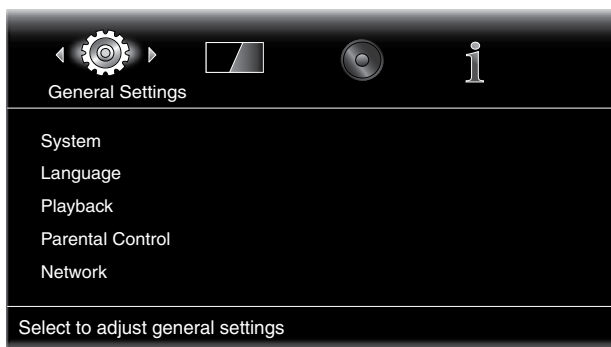

General Settings

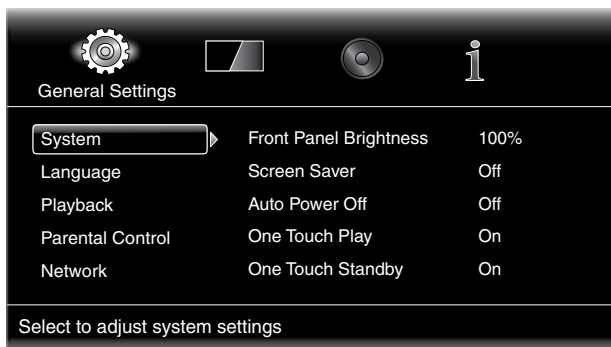

System: The System option allows you to set the following system features:

Front Panel Brightness: This option sets the brightness of the BDS receiver's information display.

Screen Saver: To prevent image burn-in, we recommended activating the Screen Saver when using the BDS receiver with a CRT or plasma TV.

Auto Power Off: This option sets the amount of time the BDS receiver remains on while idle until it automatically enters the Standby mode.

One Touch Play: When this option is set to "On," pressing the Play button on the BDS receiver when a Blu-ray Disc or DVD is inserted will automatically turn a connected TV on and switch it to the input connector where the BDS receiver is connected. NOTE: The TV must support HDMI CEC (Consumer Electronics Control).

One Touch Standby: When this option is set to "On," putting a connected TV into the standby mode will automatically place the BDS receiver into the standby mode. NOTE: The TV must support HDMI CEC (Consumer Electronics Control).

System Upgrade: Select this option when you want to install a firmware upgrade for your BDS receiver that you've downloaded from a Harman Kardon Web site or other Harman Kardon source.

Setup Wizard: This option activates the receiver's Setup Wizard (see *Setup Wizard*, on page 15).

BD-Live Storage: When you select the BD-Live features from a disc's menu, you may be able to download additional content or other information via the Internet (through the BDS receiver's Network connection) and onto a memory device inserted into the receiver's USB port. This option lets you see how much space is available on the memory device, and allows you to delete previously-stored BD-Live content from the device. See *BD-Live Interactivity*, on page 22, for details.

Restore Defaults: This option restores the receiver to its factory-default setting values. Note: This procedure deletes all preset FM stations and restores the parental-control password back to the factory default of **0000**.

Language: This setting lets you set the language for the disc player and the disc menus, the preferred audio language and the preferred subtitle language.

NOTE: If the selected language is not available on the particular disc being played, use the disc's menu to set the language from those available on the disc.

Playback: The Playback option allows you to set the following disc playback features:

Show Angle Icon: This option lets you select whether or not the angle icon will automatically be displayed when a disc with multiple camera angles is played.

Auto Play: This option lets you select whether discs will automatically begin playing when they are inserted into the BDS receiver's disc player.

Show PIP Icon: This option lets you select whether or not the picture-in-picture (PIP) icon will automatically be displayed when a Blu-ray Disc recording with PIP content is played.

Secondary Audio Icon: This option lets you select whether or not the Secondary Audio Icon will automatically be displayed when a Blu-ray Disc recording with secondary audio content is played.

Disc Resume: This option lets you select whether or not a disc that has been ejected while playing will resume play from that location when it is re-inserted into the receiver's disc player.

DivX® VOD DRM: This option displays your receiver's DivX registration information.

Parental Control: This option lets you set the receiver's parental-control password and the level of parental control you want active. NOTE: The default password is **0000**.

Network: This option allows you to set the following network features:

Information: This displays your network's IP, Subnet Mask, Gateway and DNS addresses.

Test Connection: This option tests for a proper network connection to the BDS receiver.

IP Configuration: This option lets you enter your network settings, either automatically or manually. Unless your network administrator instructs you otherwise, you should use the Auto option.

BD-Live Connection: This option lets you set the receiver's BD-Live connection preferences. "Always Allow" allows downloading of BD-Live content whenever a disc with BD-Live content is played. "Limit" allows downloading only if the disc is officially BD-Live certified. "Prohibited" does not allow any BD-Live access.

Proxy Setting: "Enabled" allows you to select and set the proxy host and proxy port if your network requires a proxy setting. "Disabled" bypasses any Proxy Host and Proxy Port settings and prevents their selection. This option is for advanced users only and in most cases should be left set to "Disabled."

Display Settings



TV: This option allows you to set the following display parameters:

Aspect Ratio: This option lets you select how you want 4:3 programs displayed on a 16:9 TV, or 16:9 programs displayed on a 4:3 TV. "16:9 Full" stretches 4:3 material to fill a 16:9 TV screen. "16:9 Normal" displays 4:3 material on a 16:9 TV with black boxes on either side of the picture, preserving the program's original visual composition without distortion. "4:3 Pan & Scan" zooms in on widescreen material to fill a 4:3 screen. "4:3 Letterbox" displays 16:9 material with black bars above and below the picture, preserving the program's original visual composition without distortion.

Resolution: This option lets you select your TV's highest resolution. "Auto" automatically selects the best resolution for your TV.

Color Space: This option lets you match the BDS receiver's video output to the color space of the connected TV or video display. Check the documentation for your TV or video display to determine the color space it uses.

Film Mode: If your TV can handle a 1080p 24Hz signal (if it has 1080 resolution and a video-refresh rate that is a whole-number multiple of 24), set Film Mode to "On" to get maximum resolution from Blu-ray Disc content mastered at 24 frames per second. If your display cannot handle a 1080p/24Hz signal, set this option to "Off," and the BDS receiver will upconvert 24-frame-per-second film material to the standard video 30Hz refresh rate.

HDMI Deep Color: This option allows you to adjust the resolution of color output to your TV. If your TV accepts Deep Color, this option allows your TV to display an enhanced color palette.

- On: The BDS receiver outputs 36-bit Deep Color if your TV supports it. If your TV does not, the receiver will output 30-bit color.
- Off: The BDS receiver does not output Deep Color (color resolution remains at 24 bits).

TV Standard: This option allows you to set the BDS receiver to match your area's television standard. Select NTSC for the USA or PAL for Europe. Select "Auto" to allow the receiver to match the standard of the connected TV automatically.

NOTE: If you use the "Auto" setting, the receiver may skip the first two seconds of PAL DivX content while it switches to the PAL mode. To avoid this, use the PAL setting.

HDMI 3D: This option lets you determine how the BDS receiver will handle HDMI 3-D content. If you have connected the receiver to a 3-D capable TV, select "Auto" to allow the receiver to play 3-D content in 3-D automatically. If you have connected the receiver to a TV that is not 3-D capable, select "Off" to play 3-D content in 2-D.

Video Processing: This option allows you to set the BDS receiver's internal video processing.

Video Mode: This setting lets you select a preset video-processing option to optimize the picture for the current program by adjusting the brightness, contrast, color and sharpness:

- Standard: Neutral control settings.
- Vivid: For video games.
- Cinema: For movies and many television broadcasts.
- Custom: This option lets you adjust the picture settings manually. The Brightness, Saturation (color saturation), Hue, Contrast, Sharpness and CTI settings appear as sliders. The default setting for each adjustment is 0. Use the Cursor Left/Right buttons to change each setting's value.

Audio Settings

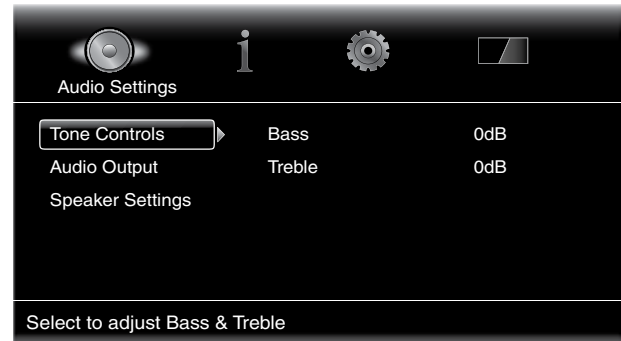

Tone controls: This option lets you increase or decrease the amount of bass (low frequencies) and treble (high frequencies) in the sound. The adjustment ranges from -10dB to +10dB, in 1dB increments.

Audio output: This option lets you set the following items:

HDMI Audio Out: In addition to digital video signals, the BDS receiver's HDMI connection also carries digital audio signals.

- PCM: This option outputs a two-channel downmix derived from the program's native audio format via the HDMI output.
- Off: This option turns the receiver's HDMI audio output off. We recommend setting this option to "Off," so you can take full advantage of the superior audio capability of your BDS receiver.

Dynamic Range Control: This setting makes the loud and quiet parts of a movie or music closer to the same volume (a process known as compression). Compression lets you turn up the volume so you can hear the quiet parts without the loud parts disturbing other people. **NOTE:** This feature works only with Dolby Digital programs that have been specially encoded. Three settings are available:

- Off: Never applies compression. Use this setting when the volume may be as loud as you desire.
- On: Always applies compression. Use this setting when you want the volume to be as quiet as possible without making it difficult to hear spoken dialogue.
- Auto: Applies compression based on information encoded in the Dolby Digital bitstream. The receiver will selectively apply compression only during the most dynamic parts of the soundtrack.

Speaker Settings: This option allows you to set up the receiver to work properly with your speakers. There are two options:

- EzSet/EQ: This option makes the supplied EzSet/EQ microphone automatically detect the capabilities of each connected speaker and optimize the BDS receiver's performance for your speakers. This will provide excellent results in most installations.
- Manual Configuration: This option lets you manually configure the BDS receiver to work with your speakers. Select this option if you wish to set up the receiver for your speakers manually or if you are unable to run EzSet/EQ calibration.

With both options, the first step is to select the configuration of your speaker system:

- 2.0: This configuration consists of left and right main speakers but no subwoofer. Selecting this configuration sends all of the bass to the left and right speakers, so be sure that they are full-range and can handle deep bass.
- 2.1: This configuration consists of left and right main speakers, plus a subwoofer.
- 3.1: This configuration consists of front left, center and front right speakers, plus a subwoofer.
- 5.1: This configuration consists of front left, front right, center, surround left and surround right speakers, plus a subwoofer.

EZ Set/EQ: The BDS receiver's EZSet/EQ™ system uses the supplied EzSet/EQ microphone to perform this important step automatically. Before beginning, be sure you have correctly connected your speakers to the BDS receiver. **IMPORTANT: Press the remote's "Disc" input button before performing the EZ Set/EQ procedure. The EZ Set/EQ procedure is only available when the Disc input is selected.**

1. Plug the supplied EzSet/EQ microphone into the BDS receiver's Headphone connector.

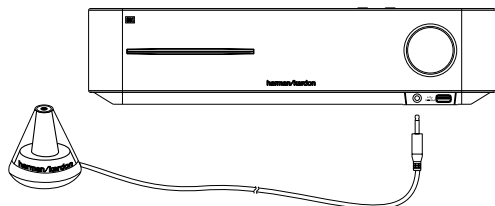

2. Place the microphone at ear height in your main listening position.
3. Press the remote control's Home button. The receiver's Home Menu screen will appear on the TV.

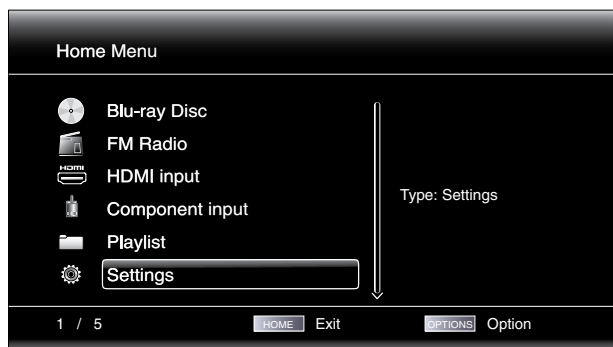

4. Use the Cursor and OK buttons to highlight and select Settings. The General Settings menu will appear.



5. Use the right Cursor button to select Audio Settings, then use the down Cursor button to select Speaker Settings. The Speaker Settings screen will appear.

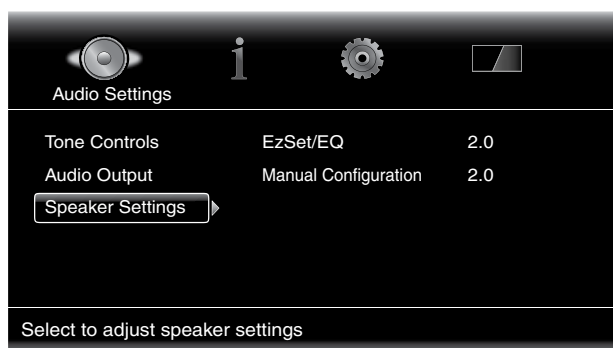

6. Press the right Cursor button to select EzSet/EQ, then use the cursor buttons to select the configuration of your speaker system.

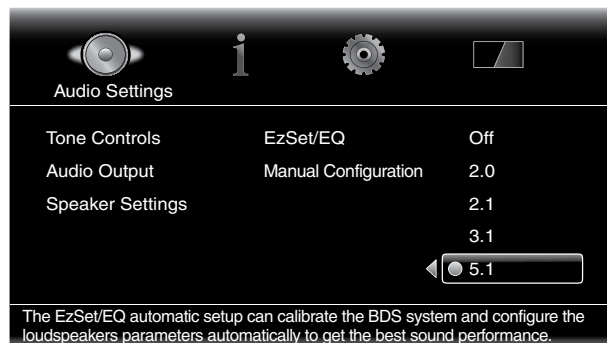

7. Press the OK button, then press it again to select Continue in the EzSet/EQ (Automatic Setup) box that appears.

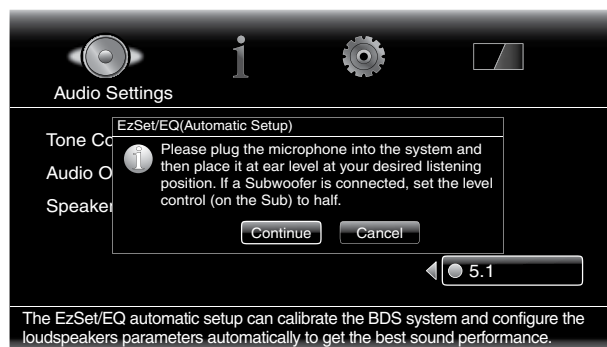

8. Remain silent while the test noise plays through the speakers. As the test noise circulates among the speakers the screen will show which speaker is being tested.

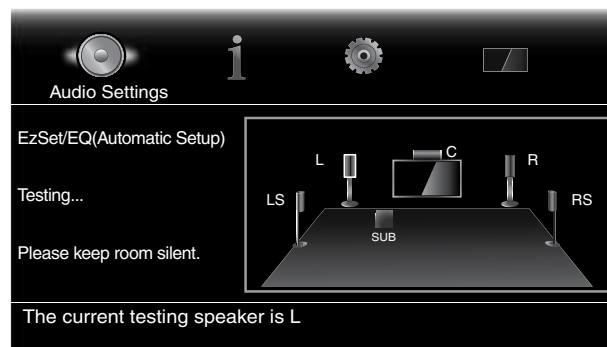

9. When the testing process is completed, the "Testing..." message on the screen will change to "All test done!"

10. Press the Clear/Exit button to exit the EzSet/EQ test procedure.

NOTE: If the test fails, the "Testing..." message on the screen will change to "Test failed, please make sure the speaker is connected correctly and room is silent, then retest." Press the Clear/Exit button, make sure all speakers are correctly connected and perform the test again from Step 6. Make sure that the room remains silent during the test.

BDS 270/BDS 570

Setting Up the Receiver and Using the Receiver

Manual Configuration: After you select your speaker system's configuration, the speaker setup screen will appear:

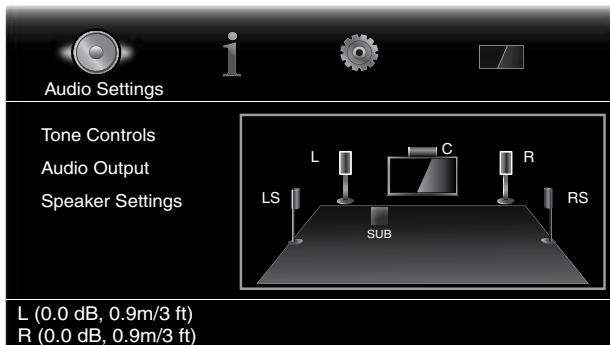

Setting the speaker distances:

1. The front left and front right speakers will be highlighted. Press the OK button. The Level and Distance selection screen will appear.

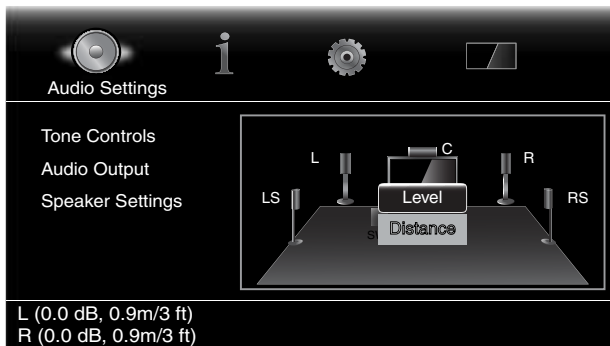

2. Press the Cursor Down button to highlight Distance, and press the OK button. The Distance adjustment bars will appear.

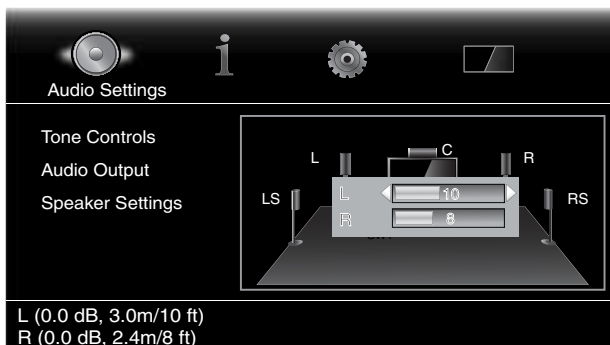

3. Measure the distance from the listening position to each of your system's speakers, including the subwoofer. Write down the distances.
4. Use the Cursor Left and Right buttons to adjust the "L" bar until it shows the distance you measured to the front left speaker (the arrowheads indicate which speaker is being adjusted).
5. Press the Cursor Down button to highlight the "R" bar. Use the Cursor Left and Right buttons to adjust the bar until it shows the distance you measured to the front right speaker.
6. Press the Clear/Exit button twice to return to the speaker setup screen (the front left and front right speakers will still be highlighted).

7. Press the Cursor Down button. The subwoofer will be highlighted. Press the OK button. The Level and Distance screen will appear.

8. Repeat Steps 2 – 7 for the center speaker, surround speakers and subwoofer.

9. When you have entered the distances to all of your system's speakers, press the Clear/Exit button repeatedly to return to the Home Menu screen.

NOTE: Leave all the speaker levels set at "0" for now. You will be able to adjust the individual speaker levels once your system is set up and you're playing music or films. See *Adjusting Individual Speaker Volumes*, on page 20.

Information Menu

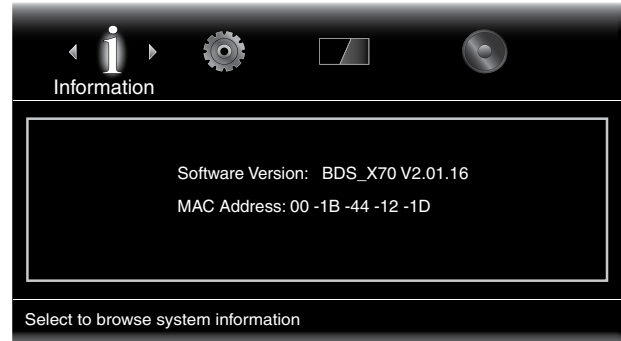

The Information menu will display the receiver's software/firmware version number and the receiver's factory-assigned network MAC address. This screen is for information only and has no user adjustments.

Using the Receiver

NOTE: Before using your new BDS receiver, be sure to set the speaker distances, as explained in *Audio Settings: Speaker Settings*, on page 17.

Home Menu

Press the Home button to display the Home Menu screen:

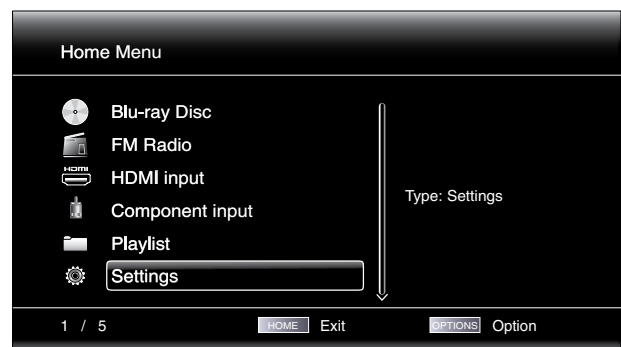

The available sources are listed on the left.

If a disc has been inserted into the receiver's built-in disc slot, it will appear on the list as either "CDDA" (CD), "DVD Video" (DVD) or "Blu-ray Disc." If you have inserted a USB device into the receiver's USB port, it will appear on the list as "USB."

NOTE: Digital and analog audio sources connected to the receiver's rear-panel digital and line inputs will not appear on the list but can be selected using the remote's "Aux" Input button (see *Listening to Audio Sources*, on page 24).

To select a source from the list, use the Cursor Up/Down buttons to highlight the desired source, then press the OK button to select it. You can also select a source directly by pressing its Input button on the remote.

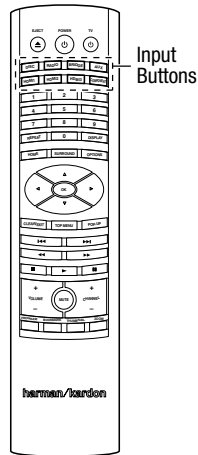

To use the Playlist function, see *Using Playlists*, on page 26.

Adjusting Individual Speaker Volumes

You can adjust the volumes of the system's individual speakers while you're listening to music.

1. Press the Home button and use the Cursor and OK buttons to select Settings. The Settings menu will appear.
2. Select the Audio Settings option. The Audio Settings menu will appear.
3. Select Speaker Settings, then select Manual Configuration, and then select your system's speaker configuration. After you select your system's configuration, the speaker setup screen will appear.

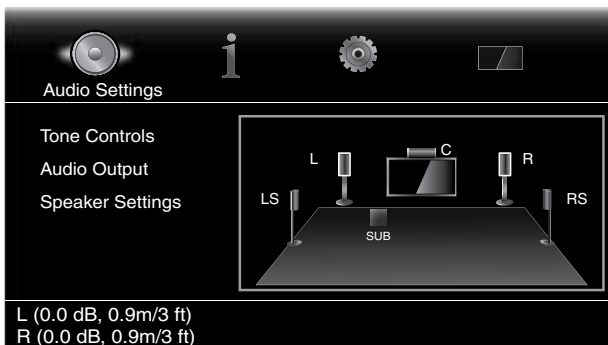

4. The front left and front right speakers will be highlighted. To adjust either of them, press the OK button. To adjust a different speaker, use the cursor buttons to highlight it, and press the OK button. The Level and Distance selection screen will appear.

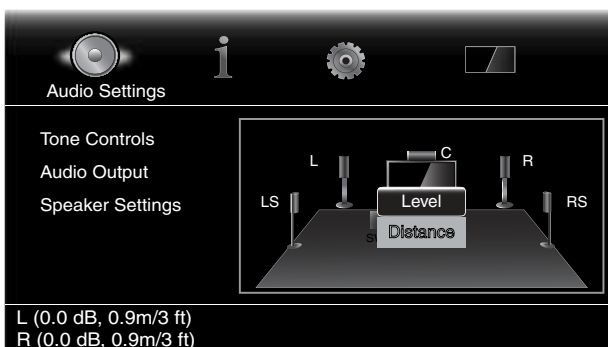

5. Make sure that Level is highlighted, and press the OK button. The Volume adjustment bars will appear.

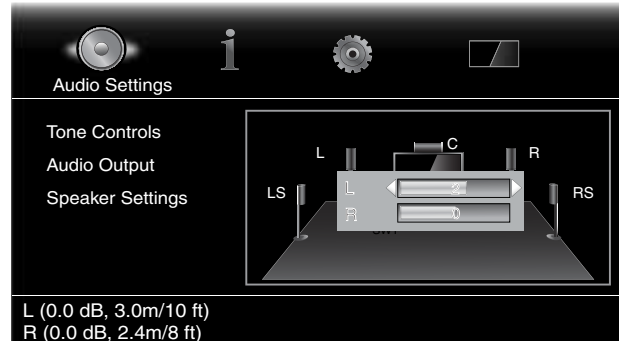

6. Select the speaker you want to adjust, and use the left and right arrow buttons to adjust its volume. You can vary the volume from +10dB to -10dB, in 1dB increments.
7. Press the Clear/Exit button twice to return to the speaker setup screen (the front left and front right speakers will still be highlighted). To adjust the volume of a different speaker, use the cursor buttons to highlight it and press the OK button. Repeat Steps 5 – 6 for that speaker.
8. When you are finished adjusting the volumes of all of your system's speakers, press the Clear/Exit button repeatedly to return to the Home Menu screen.

Notes on Setting Speaker Volumes in 5.1-Channel Systems:

While setting your system's individual speaker volume levels is ultimately up to your personal taste, here are some ideas you may find helpful:

- For films and video-music programs, your overall goal should be to create an enveloping, realistic sound field that draws you into the film or music program without drawing your attention away from the action on the screen.
- For multichannel music recordings, some music producers will create a sound field that places the musicians all around you; others will create a sound field that places the musicians in front of you, with more subtle ambience in the surround speakers (as you would experience in a concert hall).
- In most 5.1-channel films, the surround channels are not intended to be as loud or as active as the front channels. Adjusting the surround speakers so they are always as loud as the front channels could make dialogue difficult to understand and will make some sound effects sound unrealistically loud.

Notes on Setting Subwoofer Volume:

- Sometimes the ideal subwoofer volume setting for music is too loud for films, while the ideal setting for films is too quiet for music. When setting the subwoofer volume, listen to both music and films with strong bass content and find a "middle ground" volume level that works for both.
- If your subwoofer always seems too loud or too quiet, you may want to place it in a different location. Placing the subwoofer in a corner will always tend to increase its bass output, while placing it away from any walls or corners will always tend to lessen its bass output.

IMPORTANT: Do not turn the receiver's volume up to or past the point where the audio from the speakers becomes distorted. Doing so can damage the speakers.

Surround-Sound Modes

Your BDS receiver can decode and play audio programs in these native audio formats:

- Dolby Digital
- Dolby Digital Plus
- Dolby TrueHD
- DTS Digital
- DTS-HD™ High Resolution Audio
- DTS-HD Master Audio™
- PCM
- MP3: 32kbps – 320kbps bitrates, including variable bitrate encoding

The audio formats available for any particular program depend on the program and on how you have configured your BDS receiver in the *Audio Settings* menu:

Available Audio Formats

	2.0- and 2.1-Channel Setup Configuration	3.1-Channel Setup Configuration	5.1-Channel Setup Configuration
2.1-Channel Programs	Dolby Virtual Speaker Wide (default)/Dolby Virtual Speaker Reference/Stereo	Dolby PLII Movie (default)/Dolby PLII Music/Dolby Virtual Speaker Wide/Dolby Virtual Speaker Reference/Stereo	Dolby PLII Movie (default)/Dolby PLII Music/Dolby Virtual Speaker Wide/Dolby Virtual Speaker Reference/Stereo
3.1-Channel Programs	Dolby Virtual Speaker Wide (default)/Dolby Virtual Speaker Reference/Stereo	Original (default)/Dolby Virtual Speaker Wide/Dolby Virtual Speaker Reference	Original (default)/Dolby PLII Movie/Dolby PLII Music/Dolby Virtual Speaker Wide/Dolby Virtual Speaker Reference/Stereo
4.1-/5.1-/6.1-Channel Programs	Dolby Virtual Speaker Wide (default)/Dolby Virtual Speaker Reference/Stereo	Dolby Virtual Speaker Wide (default)/Dolby Virtual Speaker Reference/Stereo	Original (default)/Dolby Virtual Speaker Wide/Dolby Virtual Speaker Reference

To switch between the available surround-sound modes for the program currently playing, press the Surround button. Each press of the Surround button will change to the next available mode in line. A pop-up display will appear on the TV, showing the modes as you cycle through them.

Listening Through Headphones

Your BDS receiver's headphone connection accepts a standard 1/8-inch (3.5mm) stereo headphone plug. When you insert the headphone plug into the connector, the receiver's speaker outputs will mute; the HDMI audio output will not mute.

When headphones are connected to the receiver's Headphone jack, pressing the remote's Surround button cycles between these two modes:

- HARMAN headphone, which virtualizes a multichannel surround soundtrack down to two channels. This mode retains the soundtrack's original directional cues, allowing you to enjoy an enveloping surround-sound experience on any ordinary pair of stereo headphones.
- Headphone Bypass, which downmixes surround-sound programs into normal stereo. This mode does not retain any multichannel directional cues that may be in the original surround-sound program.

Using the Disc Player

Disc Handling Precautions

- To keep the disc clean, handle the disc by its edge. Do not touch the surface.



- Do not stick paper or tape on the disc. If there is glue (or a similar substance) on the disc, remove the substance completely before using the disc.
- Do not expose the disc to direct sunlight or heat sources such as hot air ducts or leave it in a car parked in direct sunlight, as there can be a considerable rise in temperature inside the car.
- After playing, store the disc in its case.
- Do not write on the label side with a ball-point pen or other sharp writing utensils.
- Be careful not to drop or bend the disc.

Disc Cleaning Precautions

- Before playing, clean the disc with a cleaning cloth. Wipe the disc from the center out.
- Do not use solvents such as benzine, thinner, commercially available cleaners or anti-static spray intended for vinyl LPs.

Regional Coding

Your BDS receiver is designed to be compatible with region management information that is encoded on most Blu-ray Disc recordings and DVD recordings. If there is a region code on a disc other than the one your BDS receiver is designed for, it will not play in your BDS receiver.

See the sidebar box on page 4 for complete information about your receiver's region coding.

Copyright

Audio-visual material may consist of copyrighted works that must not be recorded without the permission of the owner of the copyright. Please refer to relevant laws covering copyright protection.

Copy Protection

Your BDS receiver is in compliance with HDCP (High-Definition Copy Protection), and a video display connected via the HDMI output must also be HDCP-compliant.

The BDS receiver supports Rovi copy protection. On Blu-ray Disc recordings and DVD discs that include a copy-protection code, if the contents of the disc are copied using a VCR, the copy-protection code prevents the videotape copy from playing normally.

Supported Disc Formats

The BDS receiver can play the following types of discs (5"/12cm, and 3"/8cm size):

- BD-Video (single-layer or double-layer)
- DVD-Video
- DVD+R/+RW
- DVD-R/-RW
- CDDA (CD digital audio)
- CD-R/RW

NOTE: The compatibility and performance of dual-layer discs is not guaranteed.

Supported Media Codecs

The BDS receiver can play media recorded in the following audio/video codecs:

- MPEG 1, Layer 1
- MPEG 2, Layer 2
- MPEG 2, Layer 3
- H.264
- VC-1
- MP3 (from CD-R/RW, DVD+R/+RW, BD-R/RE and USB)
- JPEG (from CD-R/RW, DVD+R/+RW, BD-R/RE and USB)
- DivX 3.x/4.x/5.x (from CD-R/RW, DVD+R/+RW and USB)

NOTE: Due to differences in the formats of certain discs, some discs may include a mix of features, some of which are not compatible with the disc player. Similarly, although Blu-ray Disc recordings and DVDs are capable of a wide range of features, not every disc includes every capability of its system. For example, although the BDS receiver is compatible with multi-angle discs, the multi-angle feature is possible only when the disc is specially encoded for multiple-angle play. To make certain that a specific feature or soundtrack option is available, please check the options noted on the disc jacket.

The playback capability of recordable discs may vary due to variations in the quality of the disc and the recorder used to create the disc.

Loading and Playing a Disc

Hold the disc horizontally when loading it, and insert it gently into the Disc slot. The disc loading mechanism will take the disc and slide it into the unit.

- Do not load more than one disc into the Disc slot.
- Do not load the disc upside down.

After loading a disc into the player, press the Play button to begin playback.

Use the Play, Pause, Stop, Prev/Step, Next/Step, Search Forward/Slow and Search Reverse/Slow buttons to control disc playback. See *Remote Control Functions*, on page 8, for more information about the functions of these buttons.

Playback Features

Repeat: When you are playing a Blu-ray Disc recording or DVD, pressing the Repeat button cycles through the following repeat modes: Chapter, Title, All, Off. When you are playing a CD, this button cycles through the following repeat modes: Track, All, Off.

A-B Repeat: When playing a Blu-ray Disc recording, or DVD, holding the Repeat button for more than three seconds places the player into the A-B repeat mode. The next short press of the Repeat button sets the “A” repeat point; the second short press sets the “B” repeat point and begins repeating the section of the disc between the two points. Pressing the Clear/Exit button while the player is in the A-B repeat mode takes the player out of that mode. Note: This feature is disc-dependent. Not all Blu-ray Disc recordings support A-B repeat.

Options: Pressing the Options button displays any available options for the currently-playing disc. Blu-ray Disc options include title, chapter, time display, audio options, angle options, subtitle options, Find, Adjust Lip Sync, Advance and Replay. DVD options include title, chapter, time display, playback modes, audio options, angle options, Find, Adjust Lip Sync, Advance and Replay. Audio CD options include track selection, time display, playback modes, bitrate, instant search and instant replay.

Find option: Selecting the Find option during disc playback activates the search function, allowing you to jump to a specific location on the disc. You can find a location by title, chapter or time. See Top Menu Button (on this page) for more information. NOTE: Not all discs allow searching by title. On these discs, use the disc menu to change titles.

Lip Sync option: This option lets you resynchronize the audio and video signals from a Blu-ray Disc recording or DVD to eliminate a “lip sync” problem. Lip-sync issues can occur when the video portion of a signal undergoes additional processing in the video display. Use the Left/Right Cursor buttons to delay the audio by up to 250ms until it is synchronized with the video. Press the Clear/Exit button when you’re finished. NOTE: This setting will be available only when a Blu-ray Disc or DVD has been inserted into the BDS receiver’s disc drive.

Display button: When playing Blu-ray Disc recordings and DVDs, pressing the Display button toggles the information bar on and off.

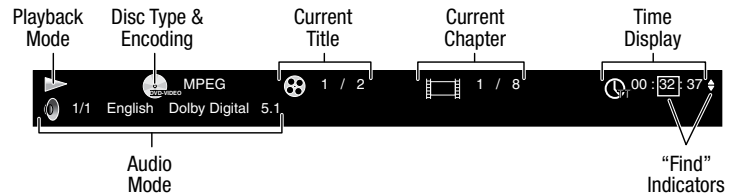

Top Menu button: Pressing this button displays the top menu for the Blu-ray Disc recording or DVD that is currently playing. NOTE: This feature is disc-dependent. Not all DVDs have top menus. If the DVD has no top menu, pressing the Top Menu button may display the disc menu, depending on how the disc’s menu system was authored.

Pop-Up button: Pressing this button while playing a Blu-ray Disc recording displays the pop-up menu. (DVDs will display the disc menu.) Note: If the Blu-ray Disc recording does not support a pop-up menu, the disc menu will be displayed.

Bookmark function: The bookmark function lets you mark up to 12 locations on the disc currently playing. Press the Bookmark button to mark the current location on the disc. To clear a bookmarked location, press the Clear/Exit button. To play the disc from one of your selected bookmark locations, hold the Bookmark button to display the bookmark list. Use the Navigation left/right buttons to select the desired bookmark, and press the OK button to play the disc from that location. NOTE: The bookmark function is disc-dependent. Not all discs allow bookmark operation.

Programmed play: This option lets you create a programmed playlist for a disc. The program function works for CDs, DVDs and some Blu-ray Disc recordings (not all Blu-ray Disc recordings allow programmed play).

1. Press the Program button. The Program screen will appear.

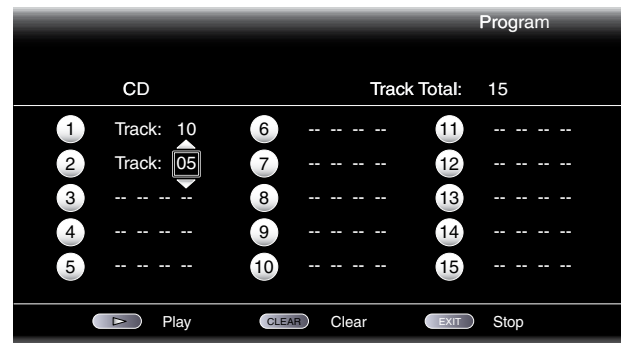

2. Press the OK button and use the Navigation Up/Down buttons to select the title on the disc (Blu-ray Disc/DVD) or track (CD) for your first program entry.
3. Press the right Navigation button and use the Navigation Up/Down buttons to select the chapter for your first program entry (Blu-ray Disc/DVD only).
4. Repeat Steps 2 – 3 for every entry in your programmed list.
5. When you’re finished programming your list, press the Play button to play the list. Press the Next/Previous buttons to skip to the next or previous programmed item. NOTE: Pressing a number button during programmed play exits the programmed play mode and skips to the selected chapter or track.

The programmed list will remain active until the list has completed playing. Pressing the Stop button twice or ejecting the disc deletes the programmed list.

BD-Live Interactivity

BD-Live interactivity is available on select Blu-ray Disc recordings. When you select the BD-Live features from a disc’s menu, you may be able to download additional content or other information via the Internet (through the Network connection).

If you have difficulty accessing the Internet while using a BD-Live disc, press the Settings button and navigate to the Network Setup menu. Select “Test Connection.” If the BDS receiver is able to access the Internet, then the computer server the BD-Live disc is trying to access may be at fault. Check the disc jacket for more information or contact the content provider. If the “Test Connection” function fails, contact your Internet service provider (ISP) to obtain the correct settings for the BDS receiver’s IP Configuration menu. If the problem persists, contact your ISP for further assistance.

Playing Music CDs

When the BDS receiver is playing a music CD, the top bar shows the current playback-mode icon, the type of disc, the track currently playing, the number of total tracks on the disc and the time display.

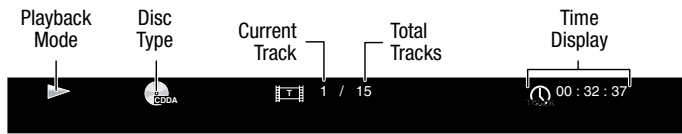

Listening to Your iPod/iPhone Device

Playing iPod/iPhone Content

Insert your iPod or iPhone device into the The Bridge IIP dock (optional, not supplied) and press the BDS receiver remote control's Bridge button. If the Home screen is displayed, highlight "The Bridge" and press the OK button. The iPod Now Playing screen will appear on the TV.



NOTE: The BDS receiver will not play video content stored on iPod or iPhone devices.

In addition to playing content from an iPod or iPhone device, pressing the Bridge button places the remote in the iPod control mode. Use the following remote control buttons to browse and select content on your iPod/iPhone device and control the device during playback:

Cursor and OK buttons: Use these buttons to navigate and select items from the iPod/iPhone menus.

Exit button: Pressing this button while playing content displays the iPod/iPhone menu. Pressing this button while a menu is displayed exits that menu and displays the previous screen.

Previous/Step button: Press this button once to skip to the beginning of the current track. Press the button twice to skip to the beginning of the previous track.

Next/Step button: Press this button to skip to the beginning of the next track.

Search/Slow Reverse button: Press this button to search backward through the current track.

Search/Slow Forward button: Press this button to search forward through the current track.

Stop button: Press this button to stop playback.

Play button: Press this button to play the item appearing on the receiver's display.

Pause button: Press this button to pause the item that is playing. Pressing this button while the iPod/iPhone device is paused will resume play.

Channel +/- buttons: Pressing the Channel + button moves up ten items in the active menu. Pressing the Channel - button moves down ten items in the active menu. Use these buttons to navigate through long menu lists quickly.

Home button: Pressing the Home button will switch the display to the Home screen while you continue to hear the iPod/iPhone content through the BDS receiver. To display the iPod Now Playing screen again, press the Exit or Cursor Left button.

Red button: Pressing the red button will toggle between the following modes: Random Play (albums), Random Play (songs), Random Off.

Repeat button: Pressing the Repeat button will cycle the iPod/iPhone device between Repeat Song, Repeat All, Repeat Off.

Receiver Information Display

When songs are playing, the display's top line will scroll "Artist <Artist Name>," "Song <Song Name>." The display's bottom line will show the time according to the iPod/iPhone time display. When the iPod/iPhone device is in the menu mode, the receiver's display will mimic the behavior of the menu that is active on the iPod/iPhone screen.

Using the Radio

Press the Radio button on the remote control, or if the Home screen is displayed on the TV, highlight Radio and press the OK button. The Radio Now Playing screen will appear on the TV.



The top line of the receiver's information display will show the currently tuned-in FM frequency; the bottom line of the display will show the RDS information for the currently-tuned station (if available).

In addition to playing the radio through the receiver, pressing the Radio button places the remote in the radio-control mode. Use the following remote-control buttons to control the receiver's FM radio:

Cursor Up/Down buttons: Pressing these buttons increases or decreases the tuned frequency by 0.05MHz.

OK button: Pressing this button sets the currently tuned-in frequency as a preset station. See *Setting and Recalling Preset Stations*, below, for details.

Previous/Step button and Next/Step button: Pressing these buttons scans to the next higher or lower receivable radio station.

Search/Slow Reverse button and Search/Slow Forward button: Pressing these buttons scans to the next higher or lower receivable radio station.

Channel +/- buttons: Pressing these buttons changes to the next higher or lower preset station.

Number buttons: Pressing a number button or a combination of number buttons will change to the corresponding preset station. See *Setting and Recalling Preset Stations*, below, for details.

Home button: Pressing the Home button will switch the TV to the Home screen while the radio continues to be heard through the BDS receiver. To display the Radio Now Playing screen again, press the Exit or Cursor Left button.

Setting and Recalling Preset Stations

You can set up to 30 preset stations for easy recall.

To set the currently tuned-in station as a preset:

1. Press and hold the OK button for three seconds. The bottom line of the receiver's information display will read "Set Preset" while the top line flashes " _ _ ".
2. Use the number buttons to enter the preset number you want the current station saved to. If you do not enter a number within ten seconds, the display line will revert back to the RDS text readout for the current station.

BDS 270/BDS 570

Using the Radio, Listening to Audio Sources and Playing Files from USB Devices and CD/DVD Data Discs

To listen to a preset station:

Press the Channel + or Channel – button. The radio will tune to the next higher or lower preset station.

– OR –

Use the number buttons to enter the preset number.

- For presets 1 – 9, press the corresponding 1 – 9 button.
- For presets 10 and higher, press the “0” button, then use the number buttons to enter the preset number.

Listening to Audio Sources

Press the Aux button on the remote control. The receiver will switch to the audio input that was selected last. Subsequent presses of the Aux button will advance through the audio inputs in the following order: Coaxial, Optical 2, Optical 1, Stereo L/R 1, Stereo L/R 2 and the HDMI ARC (Audio Return Channel).

The Aux Input Now Playing screen will appear on the TV.



In addition to playing the Aux source through the receiver, pressing the Aux button places the remote in the Aux-control mode. If you programmed the remote to control auxiliary components (either by entering in a code number or teaching commands to the remote), the remote will now operate according to that programming.

Lip sync delay: When playing an Aux source, audio and video processing circuitry may create a slight delay between the picture and sound. Pressing the Options button lets you adjust the audio delay to eliminate “lip sync” errors that may occur between the sound and picture in video programs with sound playing through one of the receiver’s rear-panel audio inputs. Use the Cursor Up/Down buttons to increase or decrease the audio delay until the perceived lip-sync errors disappear and the sound and picture are properly synchronized. The amount of audio delay is shown on the receiver’s front-panel Information display.

Playing Files from USB Devices and CD/DVD Data Discs

Your BDS receiver can play MP3 (up to 320kbps bitrate) audio files, display JPEG photos and show MPEG 1 (layer 1), MPEG 2 (layers 2 and 3), and DivX home theater profile audio/video files stored on a USB device or a CD/DVD data disc.

IMPORTANT: Only media in the FAT32 file system are compatible with your BDS receiver.

To access files on a device inserted into the receiver’s USB port, press the Home button and select USB from the source list on the screen.

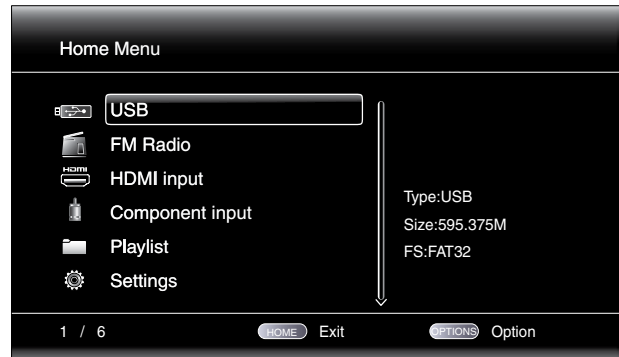

Regardless of the device’s file structure, the screen will first show three individual folders named “Photo,” “Music,” “Video” and “AVCHD (high-definition video files from AVCHD camcorders).” Select the type of media you want to play from these three folders.

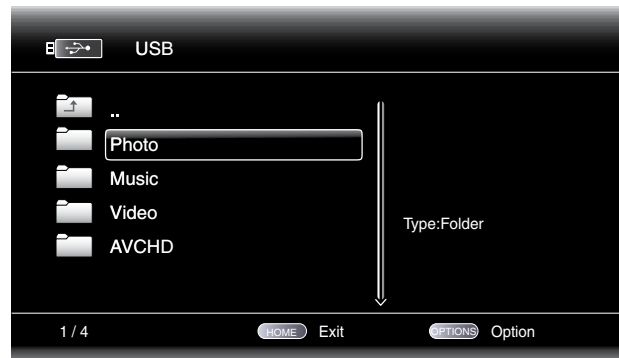

The screen will then show the device’s file structure. Selecting a folder will show all files of the selected type of media in the folder. If there are files of the selected type in the device’s root directory, they will also be shown.

To move up one directory level, press the Cursor Left button or select the arrow folder.

Viewing Photos

In the top directory, select "Photo." Select a folder containing photo files and highlight a photo file in the folder. A thumbnail of the highlighted photo will appear on the right of the screen.

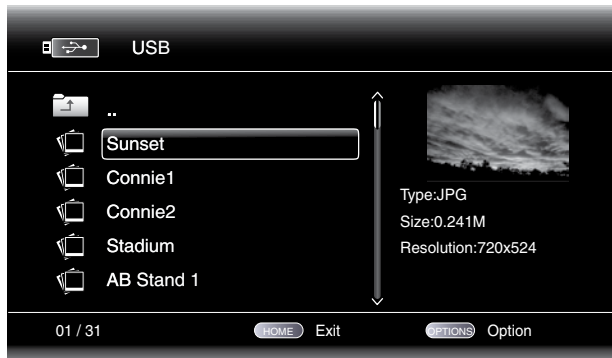

Use these remote buttons while viewing photos:

Play button: Press this button to begin a slide show that displays the photos in the current folder or directory level (starting with the highlighted JPEG) for 15 seconds in the order they appear in the folder.

Pause button: Press this button to freeze the current photo on the screen. Press the Play button to resume the slide show.

Stop button: Press to end the slide show and return to the directory.

Next/Step and Previous/Step buttons: Press these buttons to skip to the next or previous photo file in the slide show or directory.

Cursor Up button: Pressing this button while a photo is displayed rotates the photo 180°. Pressing this button while the directory list is displayed highlights the previous item in the directory.

Cursor Down button: Pressing this button while a photo is displayed shows a mirror-image reflection of the photo. Pressing this button while the directory list is displayed highlights the next item in the directory.

Cursor Left button: Pressing this button while a photo is displayed rotates the photo 90° counterclockwise. Pressing this button while the directory list is displayed jumps to the next higher directory level.

Cursor Right button: Pressing this button while a photo is displayed rotates the photo 90° clockwise.

Options button: Pressing this button while a photo is displayed shows the Options menu, which gives you the following options:

- File: Select a file to view.
- Play Mode: View files in their normal order, in random order (until you press the Stop button) or in shuffle order (displays each image in the folder one time in random order, then returns to the directory).
- Slide Show: Select the amount of time you want each slide to be displayed: 5 seconds, 15 seconds or 30 seconds.
- Transition: Select from various types of image-to-image transitions.

Pressing the Options button when a directory is displayed shows the Playlist Options box. See *Using Playlists*, on page 26, for more information.

Thumbnail (Yellow) button: Pressing this button while playing a slide show displays thumbnail images of all photos in the slide show. Use the Cursor and OK buttons to highlight and select images to view.



Zoom (Blue) button: Pressing this button during a slide show freezes an image and zooms in 2x size. Additional presses of the button change the zoom to 3x, 4x, 1/2x, 1/3x and 1/4x size.

Playing Music Files

In the top directory, select "Music." Select a folder containing music files and highlight a music file in the folder. Information about the highlighted file will appear on the right of the screen.



Selecting a music file plays the file. If there are other music files in the folder that follow the selected file, the receiver will play them in the order they appear on the on-screen display. The following screen will appear while music files play:

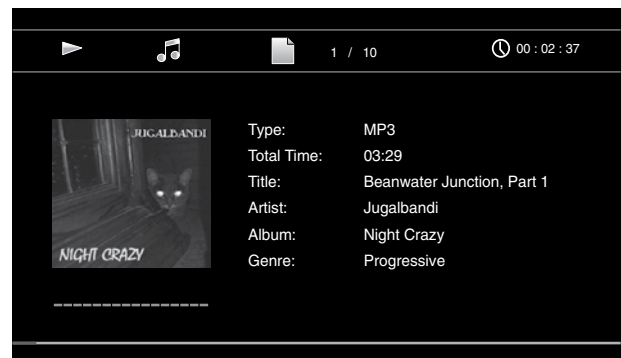

If a selected MP3 file has an album cover-art ID3 tag, the art will be displayed on the screen.

Use the Play, Pause, Stop, Prev/Step, Next/Step, Search Down/Slow and Search Up/Slow buttons to control music-file playback. See *Remote Control Functions*, on page 8, for more information about the functions of these buttons.

When the BDS receiver is playing music files from a USB device or CD data disc, the Repeat and Options functions are slightly different from when they are playing Blu-ray Disc recordings, DVDs and music CDs:

Repeat button: Pressing this button cycles through the following repeat modes: 1 (song), All (folder), Off. The active repeat mode is indicated in the screen's top bar.

Options button: Pressing this button displays any available options for the song currently playing:

- File: Select a song to play.
- Time: Display the track's elapsed time or the track's time remaining.
- Play Mode: Plays songs in their normal order, in random order (until you press the Stop button) or in shuffle order (plays each song in the folder one time in random order, then returns to the directory).
- Bitrate: Shows the bitrate of the song currently playing.
- Advance: Performs a rapid, audible search forward through the song.
- Replay: Each press of the OK button jumps back ten seconds during play.
- Find: Lets you advance to a precise time in the track. See *Find option*, on page 22, for more information.

While playing music files from a USB device or data CD, you can also view photos that are on the same media. Press the Home button while the music file is playing, navigate to a folder containing photo files, and select a photo file to begin a slide show.

Playing Videos

In the top directory, select the folder labeled "Video," or the folder labeled "AVCHD." Select a folder containing video files and highlight a video file in the active folder.

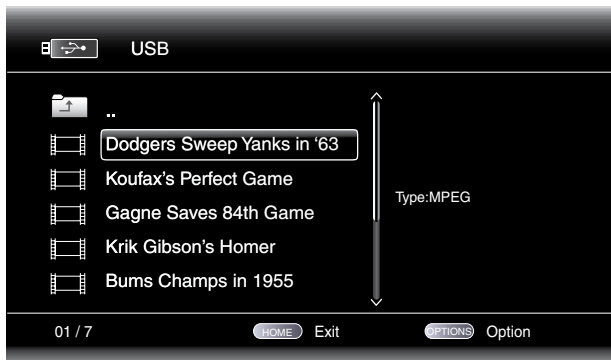

The video will automatically play. If there are other video files in the folder, the BDS receiver will play each one in the order they appear on the on-screen menu.

Use the Play, Pause, Stop, Prev/Step, Next/Step, Search Forward/Slow and Search Reverse/Slow buttons to control music file playback. See *Remote Control Functions*, on page 8, for more information about the functions of these buttons.

When the BDS receiver is playing video files from a USB device or CD data disc, the Repeat and Options functions are slightly different from playing Blu-ray Disc recordings and DVDs:

Repeat button: Pressing this button cycles through the following repeat modes: 1 (current video), All (folder), Off.

Options button: Pressing this button displays any available options for the video that is currently playing File, Title, Chapter, Time, Play Mode, Audio, Subtitle, Code Page, Bitrate, Advance, Replay, Adjust Lip Sync and Find.

Using Playlists

Because USB devices and CD data discs can contain large numbers of playable files, you can create a playlist for each that will make it easier for you to access selected files.

To Create a Playlist:

NOTE: The procedure is the same for a CD data disc playlist and a USB playlist.

1. Press the Home button. The Home menu will appear.
2. Select CD data disc or USB. The Photo, Music and Video folders will appear.
3. Select the type of file you want to create the playlist for. You can create a playlist for each type of file.
4. As you search through the directory structure, when you see a file you want to include in the playlist for that file type, highlight it and press the Options button. The playlist options box will appear.
5. To add the item to the playlist, select "Add to playlist."
6. Repeat Steps 4 – 5 for all items you want to add to the playlist.

To create a playlist for a different file type, repeat Steps 1 – 6, but in Step 3, select a different file type.

To Play a Playlist:

1. Press the Home button. The Home menu will appear.
2. Select Playlist. The Photo/Music/Video screen will appear.
3. Select the file type of the playlist you want to play. The playlist will open.
4. Select the first item in the playlist and press the Play button. The playlist will play.

To repeat the playlist, press the Repeat button. You can repeat one item ("1") or the entire playlist ("All").

Troubleshooting

If your BDS receiver isn't performing the way you think it should, check to see if the problem is covered in this section before calling your dealer or contacting a Harman Kardon representative.

Problem	Solution
The receiver won't power up (the Power indicator is not lit):	<ul style="list-style-type: none"> • Check that the receiver's Power cord is properly plugged into the receiver's AC Power connector. • Check that the Power cord is plugged into a working AC outlet. If the outlet is controlled by a switch, make sure the switch is set in the "On" position. • Check that the receiver's Main Power switch (located on the rear panel) is in the "On" position.
Sound plays through the speakers, but there is no TV picture:	<ul style="list-style-type: none"> • Check the HDMI connection between the receiver and the TV. • Check the HDMI connection or Component Video connection between the source device and the BDS receiver. • Check that the TV is turned on and is set to the proper input source. • Unplug the HDMI cable from the TV and plug it back in again.
There is no sound coming from just the <i>subwoofer</i> :	<ul style="list-style-type: none"> • Check that the subwoofer's Power cord is plugged into a working AC outlet. • Check that the subwoofer's Power switch is in the "On" position. • Check that the Subwoofer Level control is not turned all the way down (fully counterclockwise). • Check that the audio connection between the receiver and the subwoofer has been properly made. • Check the receiver's <i>Settings: Configuration</i> menu to make sure that the subwoofer volume has not been set at -10dB.
There is a constant hum in the sound:	<ul style="list-style-type: none"> • Check that all input cables are plugged all the way into their connectors. • Check that all cables are at least 10 ft (3.3m) from fluorescent lights. • Check that all cable connectors are clean. If necessary, wipe them with a cloth slightly moistened with alcohol. • Set the subwoofer's Power switch to "Off." If the hum goes away, there is a ground loop between the subwoofer and the receiver. Plugging the subwoofer's Power cord into the same AC outlet that the receiver is plugged into should eliminate the ground loop.
The disc does not play:	<ul style="list-style-type: none"> • Check that the disc is inserted correctly (label side up). • Check that the disc is the correct type: BD-Video (single-layer or double-layer), DVD-Video, DVD+R/+RW, DVD-R/-RW, CDDA (CD digital audio), CD-R/RW. Other disc types will not play. • Check that the disc surface is clean and not scratched.
There is noise or other interference in the picture while playing a Blu-ray Disc recording or DVD:	<ul style="list-style-type: none"> • Check that the disc surface is clean and not scratched.
The sound and picture are out of sync when playing to an Aux source:	<ul style="list-style-type: none"> • Press the Options button and perform the Lip Sync adjustment to bring the sound and picture into synchronization.
Cannot tune in radio stations:	<ul style="list-style-type: none"> • Check that the FM antenna is correctly connected. • Adjust the antenna's position. If necessary, use a powered FM antenna or an outdoor FM antenna.
The receiver does not respond to remote-control commands:	<ul style="list-style-type: none"> • Replace all three remote-control batteries with fresh ones, and make sure that they are installed with the correct polarity. • Hold the remote closer to the receiver. • Check that the receiver's remote sensor is in the line of sight of the remote control.
The remote does not control programmed components (TV or video):	<ul style="list-style-type: none"> • Check that you have pressed the remote's Aux button before trying to operate the component. • Re-program and/or re-teach the component's commands into the remote.
The Ø symbol appears on the screen when you press a remote-control button:	<ul style="list-style-type: none"> • The selected function is not permitted at the time the button is pressed.
The receiver does not respond to commands, or it behaves in an erratic way:	<ul style="list-style-type: none"> • Unplug the receiver's Power cord from the AC outlet, wait 30 seconds, then plug it back in.

Aux Component Remote-Control Code List

TV/DVR

Manufacturer	Code Numbers				
ADMIRAL	0192	0123	1088	1105	
AIWA	1110				
AKAI	1011	1020	1022	1042	1053
	1056	1089	1093		
ALBA	1020	1040			
ANAM	0122	0112	0109	0106	0045
AOC	0128	0123	0122	0037	
APEX	2014	2016			
ARC EN CIEL	1017	1019	1024	1056	1059
ARCAM	1017				
ARISTONA	1022	1023	1025	1033	1047
	1048	1060	1086		
ASA	1012	1023	1088	1096	1201
AUDIOVOX	0012				
AUTOVOX	1025	1044	1088		
BANG & OLUFSEN	1088				
BARCO	1202				
BASICLINE	1020				
BAUR	1075	1076	1077	1102	
BEKO	1022				
BLAUPUNKT	0084	1011	1075	1076	1077
BRANDT ELECTRONIQUE	1017	1019	1024	1056	1059
BRION VEGA	1023	1088	1203		
BROCKSONIC	0206	0205			
BUSH	1010	1020	1040	1043	1092
BUSH (UK)	1044				
CENTURY	1023	1088			
CITIZEN	0132	0128	0123	0045	
COMTEL	1032				
CONTEC	0045				
CONTINENTAL EDISON	1017	1019	1024	1056	1059
CRAIG	0159	0158	0157	0045	
CROSLEY	1023	1088			
CROWN	0132	0045			
CURTIS MATHES	0128	0123	0132		

Manufacturer	Code Numbers				
DAEWOO	0132	0128	0127	0119	0116
	0114	0111	0108	0106	0105
	0102	0087	1022		
DANSAI	1022				
DAYTRON	0132	0128			
DECCA	1091	1032			
DECCA (UK)	1038				
DEGRAAF	1015				
DISH NETWORK	2012				
DIXI	1022				
DUMONT	1201	1199	1096	1088	1023
DUMONT-FINLUX	1044	1012			
DYNATECH	0063				
DYNATRON	1022	1020			
DYNEX	0014				
ELECTROHOME	0132	0115			
EMERSON	0205	0162	0159	0158	0157
	0139	0132	0128	0123	0045
	1195	1088			
FUJITSU	0041	0042			
FUNAI	0045				
FUTURETECH	0045				
GE	0163	0159	0145	0133	0128
	0123	0121	0087	0029	
GRUNDIG	0193				
HALL MARK	0128				
Harman Kardon	0201				
HITACHI	0147	0144	0132	0128	0123
HYTEK	0016				
INKEL	0120				
JCPENNEY	0145	0132	0128	0123	0115
JENSEN	0019				
JVC	0134	0087	0079		
KEC	0045				
KLH	0006				
KTV	0162	0132	0123	0045	

TV/DVR

Manufacturer	Code Numbers					
LG (GOLDSTAR)	0132	0128	0122	0110	0101	0002
	0013	2004				
LLOYTRON	0173	0172				
LODGENET	0069					
LXI	0148	0145	0077			
MAGNAVOX	0148	0145	0132	0128	0123	0030
	0040	2007	2008	2009	2010	2011
MARANTZ	0148	0123	0115			
MEMOREX	0128	0069				
METZ	0084					
MGA	0128	0123	0115			
MITSUBISHI	0168	0167	0160	0128	0123	0115
	0077					
MTC	0176	0175				
MOTOROLA	2005					
NATIONAL	0182	0181	0180	0179	0177	0148
NEC	0125	0123	0121	0115	0010	
OLEVIA	0007					
OPTONICA	0077					
ORION	0211	0210	0209	0208	0207	
PANASONIC	0169	0148	0087			
PHILCO	0148	0132	0128	0123	0115	0045
PHILIPS	0148	0145	0132	0128	0123	0036
	0035	0034	0033			
PIONEER	0128	0123	0024			
POLAROID	0003	0004	0005	0006	0043	
PORTLAND	0132	0128				
PROSCAN	0133					
PROTON	0165	0132	0128	0122	0059	0008
QUASAR	0087	0032				
RADIO SHACK	0197	0196	0180	0132	0128	0045
RCA	0163	0161	0145	0133	0128	0123
	0115	0021	2001	2012		
REALISTIC	0196	0167	0045			
RUNCO	0153	0152	0044	0046		
SAMPO	0128	0123	0059			

Manufacturer	Code Numbers					
SAMSUNG	0145	0132	0128	0124	0022	0020
	2003					
SANYO	0054	0026				
SCOTT	0132	0128	0045			
SEARS	0145	0132	0128			
SHARP	0132	0128	0077			
SIEMENS	0084					
SIGNATURE	0069					
SONY	0212	0194	0136	0130	0117	0031
	0028					
SOUNDESIGN	0128	0045				
SYLVANIA	0148	0145	0128	0123	0025	
SYMPHONIC	0184					
TANDY	0077					
TATUNG	0063	2018				
TECHNICS	0181					
TECHWOOD	0128					
TEKNIKA	0132	0128	0123	0115	0069	0045
TELERENT	0069					
TERA	0156					
THOMSON	0191	0190				
TIVO	0051	0052	2020	2021		
TMK	0128					
TOSHIBA	0202	0129	0063			
TOTEVISION	0132					
VIDEO CONCEPTS	0160					
VIDTECH	0128					
VIEWSONIC	0011	0038	0039	0047		
VIZIO	0001	0002				
WARDS	0148	0132	0128	0069		
WESTINGHOUSE	0017	0018	0023			
YAMAHA	0128	0123				
YORK	0128					
ZENITH	0090	0069	2002	2008	2019	

Cable Tuners

Manufacturer	Code Numbers					
ABC	3011	3001				
ALLEGRO	3111					
AMERICAST	3212					
ARCHER	3112					
BELCOR	3113					
BT CABLE	4007					
CABLE STAR	3113	3033				
CABLETIME	4008	4011	4012	4016		
CITIZEN	3111					
CLYDE CABLEVISION	4017					
COMCAST	3007	4014				
DESCAT CANAL	4010					
DIGI LINK	3114					
EAGLE	3186					
EASTERN	3070	3066				
EMERSON	3112					
FILMNET	4018	4020				
FOXTEL	4019					
FRANCE TELECOM	4013	4021				
G.I.	3097	3096	3017	3011	3001	
GC ELECTRONICS	3113					
GEC	4017					
GEMINI	3060	3032				
GENERAL	3210					
GENERAL INSTRUMENT	3210					
HANLIN	3208	3175	3117	3101	3100	3099
	3056					
HITACHI	3188	3001				
JASCO	3111					
JERROLD	3210	3188	3162	3097	3096	3073
	3017	3011	3002	3001	4001	4022
LINSAY	3118					
MACOM	3191					
MAGNAVOX	3068	3019	3017			
MOVIE TIME	3039	3035				
NSC	3190	3035				

Manufacturer	Code Numbers					
OAK	3220	3197				
PACE	3179					
PANASONIC	3214	3189	3177	3176	3053	
PANTHER	3114					
PHILIPS	3090	3085	3020	3019	3013	4023
PIONEER	3216	3215	3209	3171	3119	3041
	3001	4002				
RADIO SHACK	3213	3112	3111			
RCA	3214	3053				
RECOTON	3116					
REGAL	3208	3101	3100	3099	3056	
REMBRANDT	3032					
SAGEM	4028					
SAMSUNG	3003	3186	3072	4002	4003	4024
SATBOX	4004					
SCIENTIFIC ATLANTA	3222	3221	3203	3183	4005	4006
	4025	4026				
SEAM	3121					
SIGNATURE	3188	3001				
SPRUCER	3189	3177	3081	3053		
STARCOM	3163	3011	3002			
STARGATE	3120					
TANDY	3024					
TELECAPATION	3028					
TELESERVICE	4011					
TEXSCAN	3036					
TFC	3122					
TIVO	3029	3030	4029	4030		
TOCOM	3205	3170				
TUDI	4027					
UNITED CABLE	3011	4001				
UNIVERSAL	3113	3042	3039	3034	3033	
VIDEOWAY	3211	3124				
VIEWSTAR	3190	3089	3086	3053	3025	3019
VISIOPASS	4009					
WESTMINSTER CABLE	4007					
ZENITH	3219	3211	3125	3065		

Satellite Tuners

Manufacturer	Code Numbers					
AIWA	6041					
AKAI	6033					
ALBA	6001	6011				
AMSTRAD	6032					
ANKARO	6021					
ASTRO	6076	6077	6078	6079	6080	6081
	6082	6083				
BARCOM	6021					
BIRDVIEW	5025					
BLAUPUNKT	6038	6090				
BUSH	6006	6048				
BUSH (UK)	6053					
CANAL	6013					
CANAL DIGITAL	6013					
CANAL PLUS (CANAL +)	6013					
CHANNEL MASTER	5061	5025	5021	5020		
CHAPARRAL	5051	5016	5015			
CITOH	5060					
DIRECTV	5009	5010	5014	6002	6003	6005
DISH NETWORK	5064					
DRAKE	5081	5013	5018	5017	5013	
DX ANTENNA	5083	5079	5052	5031		
ECHOSTAR	5085	5084	5078	5077	5063	5053
	5052	5097	5095	5064	6047	
ELECTRO HOME	5092					
FERGUSON	6006	6011	6024	6045	6048	6052
FINLUX	6009	6010				
FOXTEL	6016					
FTE	6080					
FUBA	6014	6021	6047			
FUJITSU	5034	5029	5024			
GENERAL INSTRUMENT	5074	5068	5054	5003	5065	5023
	2011	5003				
GOODMANS	6011					
GRUNDIG	6015	6038	6053	6067	6090	

Manufacturer	Code Numbers					
HITACHI	5055	5004	6006	6011		
HOUSTON TRACKER	5063					
HUGHES	5089	5037	5005	5006		
HUMAX	6007					
ITT	6067					
ITT-NOKIA	6067					
JANIEL	5066					
JERROLD	5084	5068	5054			
KATHREIN	6001	6033	6080	6090		
KOSMOS	6080					
KYOTO GMI ATLANTA	6043					
LEGEND	5053					
LEMON	6074					
LOEWE	6075					
LORENZEN	6061	6063	6064	6065	6074	
MACOM	5071	5070	5069	5065	5017	
MAGNAVOX	5073	5061				
MARANTZ	6033					
MASPRO	6006	6053				
MEMOREX	5053					
METZ	6090					
MINERVA	6090					
MITSUBISHI	5007	6090				
MOTOROLA	5012	5019				
MULTISTAR	6080					
NEC	6030	6036	6046	6073		
NETA P562	6040					
NEXTWAVE	5023					
NOKIA	6067					
NORSAT	5073	6046				
OPTIMUS	5066					
OTTO VERSAND	6090					
PACE	5087	5028	6024	6048	6053	6063
	6064	6067				
PACE MSS SERIES	6067					

Satellite Tuners

Manufacturer	Code Numbers					
PANASONIC	5069	5066	5057	5053	6024	6031
PANSAT	5020					
PERSONAL CABLE	5018					
PHILIPS	5075	6019	6021	6024	6032	6033
	6053					
PICO	5007					
PREMIERE	6008					
PRESIDENT	5004	5081				
QUADRAL	6066	6067	6068	6069	6070	6071
QUELLE	6090					
RADIOLA	6053					
RADIX	6047					
RCA	5090	5065	5039	5001	5058	5058
REALISTIC	5080	5049				
SAMSUNG	5042	5022	5026	6027	6032	6080
SAT	6027					
SATELLITE SERVICE	5088	5035				
SCIENTIFIC ATLANTA	5039	5056				
SCHNEIDER	6053					
SIEMENS	6038	6090				

Manufacturer	Code Numbers					
SKY	6006					
SKY MASTER	6033					
SKYLAB	6021					
SONY	5005	5062				
STAR CHOICE DBS	5059					
STARCAST	5047					
SUPER GUIDE	5023	5027				
TECHNISAT	6047					
TEECOM	5009	5093	5091	5090	5033	5030
TELECOM	6041					
TELEFUNKEN	6083					
THORN-FERGUSON	6023	6045	6048	6052	6053	6063
TOPPFIELD	6011					
TOSHIBA	5070	5062	5061	5060	5026	5002
UNIDEN	5080	5079	5066	5003	5089	5083
	5054	5051	5050	5049	5048	5032
VIASAT	6012					
VORTEC	6032	6042				
WISI	6004	6022	6026	6027	6047	
ZEHNDER	6027	6080				
ZENITH	5088	5019	5094	5087	5085	5084

Specifications

BDS 570 Receiver and BDS 270 Receiver

Audio Section

Continuous average power, stereo model:	65 watts per channel, 20Hz – 20kHz, @ <0.1% THD, both channels driven into 6 ohms
Multichannel power (BDS 570 only):	65 watts per channel, 20Hz – 20kHz, @ <0.1% THD, into 6 ohms
Input sensitivity/impedance (line inputs):	250mV/46k ohms
Signal-to-noise ratio (IHF-A):	-90dB
Frequency response @ 1W (±0.5dB):	20Hz – 20kHz
Slew rate:	40V/μsec

FM Tuner Section

Frequency range:	87.5MHz – 108.0MHz (US and EU)
Usable sensitivity IHF:	>14dBf
Signal-to-noise ratio (mono/stereo):	-60dB/-55dB
Distortion (mono/stereo):	0.3%/0.5%
Stereo separation:	-45dB @ 1kHz
Image rejection:	-70dB
IF rejection:	-80dB

Disc Player Section

Supported disc formats:	5-inch (12cm) or 3-inch (8cm) BD-Video (single-layer or double-layer), DVD-Video, DVD+R/+RW, DVD-R/-RW, CDDA (CD digital audio), CD-R/RW discs
Region code (BD/DVD):	
Model / Area where sold:	
BDT 3 / USA, Canada:	A/1
BDT 30 / Europe, Middle East:	B/2
BDT 30 / Korea, S. E. Asia:	A/3
BDT 3 / Mexico, Latin America:	A/4
BDT 30 / Australia, New Zealand:	B/4
BDT 30 / Russia, India:	C/5
BDT 30 / China:	C/6
Audio formats:	Dolby Digital, Dolby Digital Plus, Dolby TrueHD, DTS Digital, DTS-HD High Resolution Audio, DTS-HD Master Audio, PCM, MP3: 32kbps – 320kbps bitrates, including variable-bitrate encoding
Still-image formats:	JPEG, GIF and PNG
Video signal system:	NTSC (USA) or PAL (EU)
Frequency response:	20Hz – 20kHz ±0.5dB
Signal-to-noise ratio:	-90dB (A-weighted)
Dynamic range:	90dB (16-bit)
THD @ 1kHz (DVD/CD):	0.1%
Wow & flutter:	Below measurable limits

Video Section

Television format:	NTSC or PAL (selectable)
HDMI version:	v.1.4a with 3-D and 30/36-bit Deep Color

General

Power requirement:	110 – 240V AC, 50/60Hz
Power consumption:	130W maximum (BDS 570), 90W maximum (BDS 270); <1W standby
Dimensions (H x W x D):	4" x 15-25/32" x 10-1/4" (102mm x 401mm x 260mm)
Weight:	14.3 lb (6.5kg) (BDS 570); 14 lb (6.4kg) (BDS 270)

Depth measurement does not include terminal connections. Height measurement includes feet and chassis.



HARMAN

HARMAN Consumer, Inc.
8500 Balboa Boulevard, Northridge, CA 91329 USA
516.255.4545 (USA only)

Made in P.R.C.

© 2011 HARMAN International Industries, Incorporated. All rights reserved.

Harman Kardon is a trademark of HARMAN International Industries, Incorporated, registered in the United States and/or other countries. EzSet/EQ is a trademark of HARMAN International Industries, Incorporated. Blu-ray Disc and BD-Live are trademarks of the Blu-ray Disc Association. DIVX: ABOUT DIVX VIDEO: DivX® is a digital video format created by DivX, LLC, a subsidiary of Rovi Corporation. This is an official DivX Certified® device that plays DivX video. Visit divx.com for more information and software tools to convert your files into DivX video. ABOUT DIVX® VIDEO-ON-DEMAND: This DivX Certified® device must be registered in order to play purchased DivX Video-on-Demand (VOD) movies. To obtain your registration code, locate the DivX VOD section in your device setup menu. Go to vod.divx.com for more information on how to complete your registration. DivX®, DivX Certified® and associated logos are trademarks of Rovi Corporation or its subsidiaries and are used under license. DivX Certified® to play DivX® video up to HD 1080p, including premium content. DOLBY DIGITAL PLUS TRUE-HD: Manufactured under license from Dolby Laboratories. Dolby and the double-D symbol are registered trademarks of Dolby Laboratories. DTS DIGITAL SURROUND: Manufactured under license under U.S. Patent #s: 5,956,674; 5,974,380; 6,487,535 & other U.S. and worldwide patents issued & pending. DTS, the Symbol and DTS and the Symbol together are registered trademarks, and DTS-HD, DTS-HD Master Audio, DTS Digital Surround and the DTS logos are trademarks, of DTS, Inc. Product includes software. © DTS, Inc. All Rights Reserved. HDMI, the HDMI logo, and High-Definition Multimedia Interface are registered trademarks of HDMI Licensing LLC in the United States and other countries. iPhone and iPod are trademarks of Apple Inc., registered in the U.S. and other countries. iPod and iPhone not included. Java, Java Powered and the Java Steaming Coffee Cup logo are trademarks or registered trademarks of Sun Microsystems, Inc., or its subsidiaries in the United States and other countries. Microsoft, Windows and Windows Media are registered trademarks of Microsoft Corporation in the United States and/or other countries. This item incorporates copy-protection technology that is protected by U.S. patents and other intellectual-property rights of Rovi Corporation. Reverse engineering and disassembly are prohibited.

Features, specifications and appearance are subject to change without notice.

Part No. 950-0364-001

harman/kardon
by HARMAN

www.harmankardon.com